

# Traffic Impact Assessment: Khoe Wind Energy Facility (WEF), near De Doorns

Prepared for: ERM (Environmental Resources Management Southern Africa (Pty) Ltd)

5 August 2024

Client Reference No. 0695823\_TIA







SMEC simplifies the complex. We unlock the potential of our people to look at infrastructure differently, creating better outcomes for the future.



engineering  
positive  
change



## Document Control

<b>Document Type</b>	Traffic Impact Assessment Report
<b>Project Title</b>	Traffic Impact Assessment: Khoe WEF, near Beaufort West
<b>Project Number</b>	JT0075
<b>File Location</b>	\\ZAJHFPV002.sjgroup.local\A000 Work on Risk\PI1\2023\Small Bid folder\JT0075 - Hugo and Khoe Energy Facilities\07 Technical\TIA Report\Khoe WEF Report (.docx)
<b>Revision Number</b>	01

## Revision History

Revision No.	Date	Prepared By	Reviewed By	Approved for Issue By
00	9/05/2024	Reabetswe Mokomele Siphelele Ndwandwe	Reabetswe Mokomele	Victor de Abreu
01	5/08/2024	Reabetswe Mokomele Siphelele Ndwandwe	Reabetswe Mokomele	Victor de Abreu

## Issue Register

Distribution List	Date Issued	Number of Copies
ERM (Environmental Resources Management Southern Africa (Pty) Ltd)	16/05/2024	01
ERM (Environmental Resources Management Southern Africa (Pty) Ltd)	5/08/2024	02

## SMEC Company Details

<b>Approved by</b>	Victor de Abreu
<b>Address</b>	267 Kent Avenue, Ferndale, Johannesburg, 2194, South Africa
<b>Phone</b>	+27 11 369 0600
<b>Email</b>	<a href="mailto:Victor.deAbreu@smec.com">Victor.deAbreu@smec.com</a>
<b>Website</b>	www.smec.com
<b>Signature</b>	

The information within this document is and shall remain the property of: ERM (Environmental Resources Management Southern Africa (Pty) Ltd)

## Important Notice

This report is confidential and is provided solely for the purposes of the Traffic Impact Assessment for the Khoe Wind Energy Facility to support the Environmental Impact Assessment (EIA) by ERM (Environmental Resources Management Southern Africa (Pty) Ltd). This report is provided pursuant to a Consultancy Agreement between SMEC South Africa (Pty) Ltd (“SMEC”) and ERM (Environmental Resources Management Southern Africa (Pty) Ltd), under which SMEC undertook to perform a specific and limited task for ERM (Environmental Resources Management Southern Africa (Pty) Ltd). This report is strictly limited to the matters stated in it and subject to the various assumptions, qualifications, and limitations in it and does not apply by implication to other matters. SMEC makes no representation that the scope, assumptions, qualifications, and exclusions set out in this report will be suitable or sufficient for other purposes nor that the content of the report covers all matters which you may regard as material for your purposes.

This report must be read as a whole. The executive summary is not a substitute for this. Any subsequent report must be read in conjunction with this report.

The report supersedes all previous draft or interim reports, whether written or presented orally, before the date of this report. This report has not and will not be updated for events or transactions occurring after the date of the report or any other matters which might have a material effect on its contents, or which come to light after the date of the report. SMEC is not obliged to inform you of any such event, transaction, or matter nor to update the report for anything that occurs, or of which SMEC becomes aware, after the date of this report.

Unless expressly agreed otherwise in writing, SMEC does not accept a duty of care or any other legal responsibility whatsoever in relation to this report, or any related enquiries, advice, or other work, nor does SMEC make any representation in connection with this report, to any person other than ERM (Environmental Resources Management Southern Africa (Pty) Ltd). Any other person who receives a draft or a copy of this report (or any part of it) or discusses it (or any part of it) or any related matter with SMEC, does so on the basis that he or she acknowledges and accepts that he or she may not rely on this report nor on any related information or advice given by SMEC for any purpose whatsoever.



# Contents

<b>1</b>	<b>Introduction</b>	<b>1</b>
1.1	Background	1
1.2	Objectives	2
1.3	Project Overview	3
1.4	Study Area	5
<b>2</b>	<b>Status Quo</b>	<b>6</b>
2.1	Land Use	6
2.2	Surrounding Road Network	6
2.2.1	Road Hierarchy	6
2.2.2	Key Intersections	7
2.3	Data Collection and Traffic Volumes	8
2.3.1	Current Traffic Volumes	8
2.3.2	Provincial Roads and SANRAL Counts	9
2.3.3	Non-Motorised Transport and Public Transport	10
<b>3</b>	<b>Development Layout</b>	<b>10</b>
3.1	Planning Guidelines	10
3.2	WTG Layout	10
3.3	Associated Infrastructure	11
<b>4</b>	<b>Access Planning</b>	<b>12</b>
4.1	Main Access Points	12
4.2	Access Points to Respective WTG sites	15
4.3	Primary Access Roads and Design Considerations	15
4.4	Sight Distance Assessment	18
<b>5</b>	<b>Transportation Route</b>	<b>19</b>
5.1	Port of Entry	19
5.1.1	Route Option 1 from Port of Cape Town	20
5.1.2	Route Option 2 from Port of Mossel Bay	21
5.1.3	Route Option 3 from Port of Saldanha Bay	22
<b>6</b>	<b>Identification of Transport Impact</b>	<b>24</b>
6.1	Trip Generation	24
6.1.1	Construction Phase Traffic	24
6.1.2	Operational Phase Traffic	28
6.1.3	Decommissioning Phase Traffic	29
6.2	Trip Distribution	29
6.3	Traffic Analysis Results	30
6.3.1	Background	30
6.3.2	Intersection Capacity Operation Analysis	30
<b>7</b>	<b>Transport Management Plan</b>	<b>35</b>
7.1	Abnormal Weights and Dimension	35
7.1.1	Evaluation of Abnormal Weights and Dimensions	35
7.1.2	Permit Requirements	35
7.1.3	Types of Abnormalities	36
7.2	Impact on Road Users	36
<b>8</b>	<b>Traffic Impact Ratings</b>	<b>38</b>
8.1	Methodology	38
8.2	Assumptions and Limitations	38
8.3	Assumptions and Limitations	39
8.3.1	Impact Significance for Construction Phase	39
8.3.2	Impact Significance for Operation Phase	43
8.3.3	Impact Significance for Decommissioning Phase	47
8.4	Assessment of Cumulative Development Impacts	51
<b>9</b>	<b>Conclusions and Recommendations</b>	<b>56</b>

## Appendices

Appendix A – Project Description: Khoe	
Appendix B – WTG Layout Khoe WEF	
Appendix C – Existing Surrounding Road Network	
Appendix D – Existing Intersections	
Appendix E – Existing Traffic	
Appendix F – Provincial Roads and SANRAL Counts	
Appendix G – Building Lines	
Appendix H – Standard Plans	
Appendix I – Sight Distance Assessment	
Appendix J – Traffic Flow Diagrams	
Appendix K – Impact Assessment Methodology	
Appendix L – Specialist Declaration Form_August 2023	
Appendix M – Specialist Detailed CV	

## Figures

Figure 1-1: Locality Plan (Source: Google Earth) .....	1
Figure 1-2: Aerial View (Source: <a href="http://csg.drdlr.gov.za/">http://csg.drdlr.gov.za/</a> ) .....	2
Figure 1-3: Turbine Specifications and Typical Components .....	3
Figure 1-4: Key Parts of a Wind Turbine .....	4
Figure 1-5: Proposed Khoe WEF Layout .....	4
Figure 2-1: Road Network Hierarchy .....	6
Figure 2-2: Road Network Peak Hour Traffic (vehicles per hour) .....	8
Figure 4-1: Proposed Access Locations (Source: Google Earth Pro) .....	12
Figure 4-2: Shoulder Sight Distance for Stop Condition .....	18
Figure 5-1: Option 1 Route (Source: Google Earth Pro) .....	20
Figure 5-2: Option 2 Route (Source: Google Earth Pro) .....	21
Figure 5-3: Option 3 Route (Source: Google Earth Pro) .....	22
Figure 6-1: Project Phases .....	24
Figure 6-6: Construction Labour Force Breakdown .....	27
Figure 7-1: Stop-Go Operation (Source: Temporary Traffic Management Design Guidance) .....	37
Figure 8-1: Wind and Solar developments with an approved Environmental Authorisation or Applications under consideration within 30 km of the proposed area .....	51

## Tables

Table 1-1: KWE Cluster Land Parcels .....	2
Table 2-1: Typical 12-Hour and Daily Traffic Volumes .....	9
Table 3-1: WTG positions relative to adjacent provincial road centre line .....	11
Table 3-2: WTG positions relative to adjacent intersecting centre lines of provincial roads .....	11
Table 3-3: WTG positions relative to toppling offset distance from adjacent provincial road reserves .....	11
Table 3-4: Preferred Associated Infrastructure .....	11
Table 3-5: Alternative Associated Infrastructure .....	11
Table 4-1: Existing and Proposed Accesses .....	13
Table 4-2: Proposed Access Spacing Evaluation .....	14
Table 4-3: Minimum Spacing Requirements for full intersections on Mobility Roads .....	15
Table 4-4: Minimum spacing distances of driveways/public roads intersecting with through roads in rural roadside development environments .....	15



Table 4-5: Design Vehicles and Expected Infrastructure .....	17
Table 4-6: Sight Distance Assessment.....	18
Table 6-1: WEF Components to be transported.....	25
Table 6-2: Construction Period Trip Generation .....	27
Table 6-3: Operation Phase Trip Generation .....	28
Table 6-4: Decommissioning Trips Generated.....	29
Table 6-5: Typical Traffic Growth Rates.....	30
Table 6-6: Intersection Capacity Based Level of Service Criteria .....	30
Table 6-7: 2024 Existing AM and PM Peak Hour Results .....	31
Table 6-8: 2024 Existing + Construction Phase AM and PM Peak Hour Results .....	32
Table 6-9: 2029 Background + Construction Phase AM and PM Peak Hour Results.....	33
Table 6-10: 2046 Background + Decommission Phase AM and PM Peak Hour Results .....	34
Table 7-1: Escort Vehicles .....	36
Table 8-1: ERM Impact Assessment Methodology .....	38
Table 8-2: Impact Summary Table for Construction Phase – Increased General Traffic.....	39
Table 8-3: Impact Summary Table for Construction Phase – Abnormal Heavy Traffic.....	40
Table 8-4: Impact Summary Table for Construction Phase – Dust Generation .....	41
Table 8-5: Impact Summary Table for Construction Phase – Deterioration of Surrounding Road Network .....	42
Table 8-6: Impact Summary Table for Operational Phase – Increased General Traffic.....	43
Table 8-7: Impact Summary Table for Operational Phase – Abnormal Heavy Traffic.....	44
Table 8-8: Impact Summary Table for Operational Phase – Dust Generation .....	45
Table 8-9: Impact Summary Table for Operational Phase – Deterioration of Surrounding Road Network .....	46
Table 8-10: Impact Summary Table for Decommission Phase – Increased General Traffic.....	47
Table 8-11: Impact Summary Table for Decommission Phase – Abnormal Heavy Traffic .....	47
Table 8-12: Impact Summary Table for Decommission Phase – Dust Generation .....	49
Table 8-13: Impact Summary Table for Decommission Phase – Deterioration of Surrounding Road Network .....	50
Table 8-14: Wind and Solar developments with an approved Environmental Authorisation or Application .....	51
Table 8-15: Cumulative Impact – Increased General Traffic .....	52
Table 8-16: Cumulative Impact – Abnormal Heavy Traffic .....	53
Table 8-17: Cumulative Impact – Dust.....	54
Table 8-18: Cumulative Impact – Deterioration of surrounding road network .....	55

# 1 Introduction

## 1.1 Background

SMEC South Africa (Pty) Ltd was appointed by ERM (Environmental Resources Management Southern Africa (Pty) Ltd) to undertake a Traffic Impact Assessment (TIA) for the proposed Khoe Wind Energy Facility (WEF) and associated Infrastructure. This TIA is a Specialist Study: Traffic and Transportation intended to support the Environmental Impact Assessment (EIA) approval application for the proposed WEF development.

The proposed development named Khoe WEF is located approximately 50 km southeast of the town of De Doorns, 80 km east of the town of Worcester within the jurisdiction of the Langeberg Local Municipality, Cape Winelands District Municipality, Western Cape Province.

The proposed Khoe WEF is planned to comprise up to 29 turbines with a maximum output capacity of up to 290 MW. The location of the proposed Khoe WEF is shown in Figure 1-1 and will be located on five (5) land parcels which are indicated on an aerial view of the site in Figure 1-2 and summarised in Table 1-1.

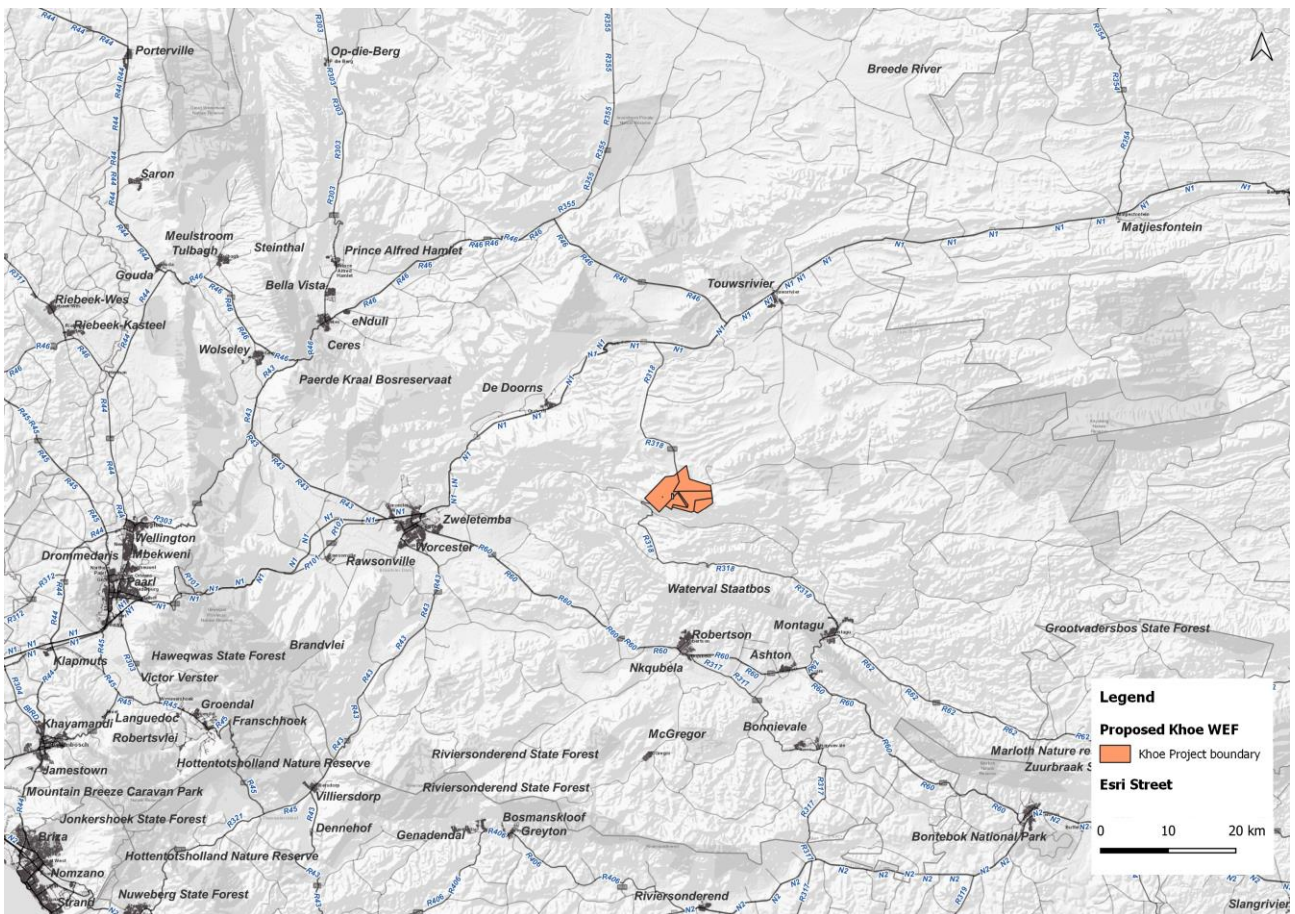

Figure 1-1: Locality Plan (Source: Google Earth)



Figure 1-2: Aerial View (Source: <http://csg.drdr.gov.za/>)

Table 1-1: KWE Cluster Land Parcels

Farm Portion (s) Description	Farm No.	Portion (s)
Portion 1 of the Farm Eendragt No. 38	38	1
Portion 2 of the Farm Eendragt No. 38		2
Portion 11 of the Farm Eendragt No. 38		11
Plaas No. 193	193	0
Remaining Portion of the Farm Eendragt No. 37	37	RE

## 1.2 Objectives

The purpose of this report is to:

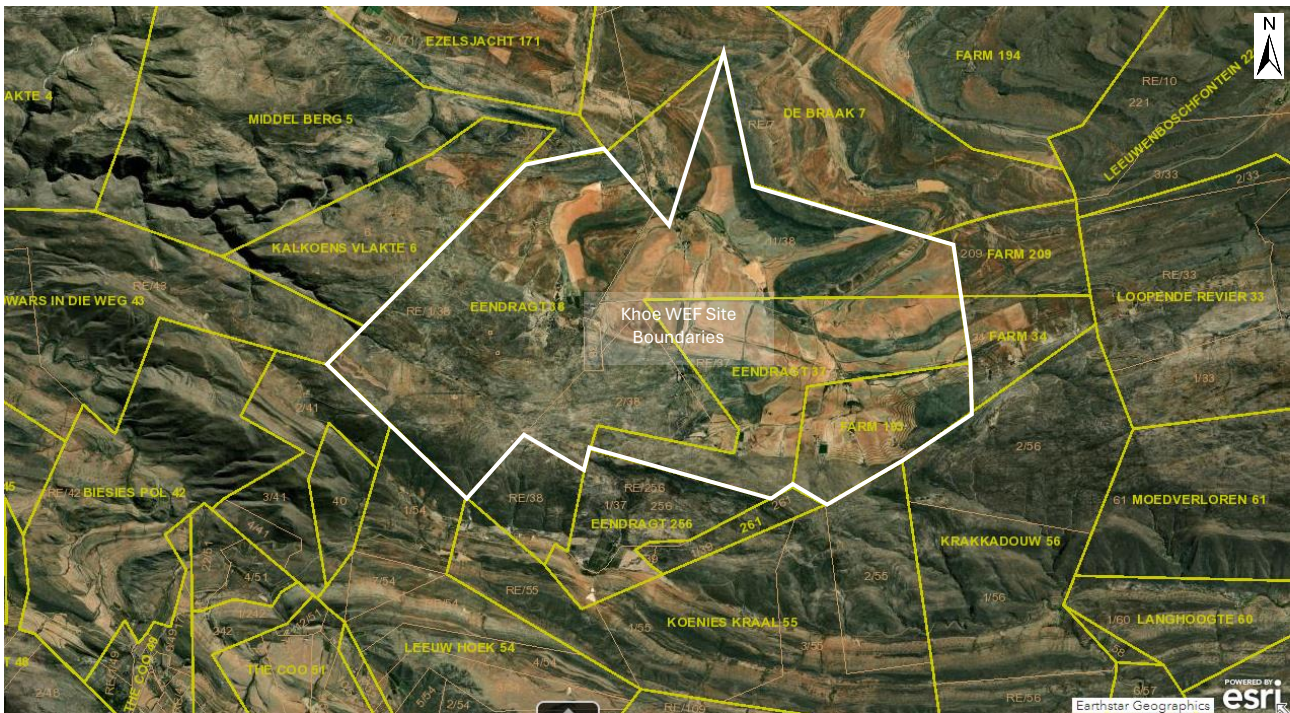
- Evaluate the impacts of the proposed development on the existing surrounding road network and associated traffic volumes on the affected roadways;
- Determine the specific traffic needs during the different stages of implementation, namely construction and installation, operations, and decommissioning;
- Evaluate the intersection capacity of the affected existing road network;
- Identify the position and suitability of the preferred access roads for the development;
- Confirm the associated clearances required for the necessary equipment to be transported from the point of delivery to the various implementation sites;
- Confirm freight and transport requirements during initial construction, operation, maintenance and decommissioning phases;
- Propose routes connecting the origins and destinations of site specific equipment;
- Advise on (abnormal load) permit requirements; and
- Reporting.

## 1.3 Project Overview

The following is a summary of project technical details of the Khoe WEF. Details of the proposed overall layout of the grid connection and associated infrastructure are indicated in Appendix A – Project Description: Khoe. The proposed layout of the Khoe WEF development is expected to generate output capacity of up to 290 MW. Components of the WEF include but are not limited to the following:

- Up to 29 Wind Turbine Generators (WTG);
- Hub height (from ground level) up to Maximum 150 m;
- Rotor diameter up to maximum 200 m;
- Blade length up to 100 m;
- Structure height (tip height) up to 250 m;
- On-site substation (OSS) with capacity of 33 kV to 132 kV and inverter transformer stations/substations occupying an area of up to 2.5 ha;
- Operations and maintenance buildings (O&M Building) are up to 1.0 ha with parking area;
- Battery Energy Storage System (BESS) with a footprint area up to 5 ha;
- Laydown area for permanent and construction laydown areas of up to 9 ha;
- Site access will be via the existing R318, and access roads will be constructed or upgraded to provide access to the WEF from new or existing internal roads;
- Internal roads with a width of approximately 4.5 m and a servitude of 13.5 m providing access to the site and between project components; and
- Water supply  $\pm 24500\text{m}^3$  for the construction, commissioning, and test phase ( $\pm 26$  months), the majority being consumed during year-one of the construction with an estimated consumption of  $90\text{m}^3/\text{annum}$  for the life-of-WEF (20-25 years).

The general WTG specifications (dimensions) and typical main components are schematically depicted in Figure 1-3 and Figure 1-4, respectively. The proposed layout of WTG's across respective land parcels is shown in Appendix B – WTG Layout Khoe WEF.

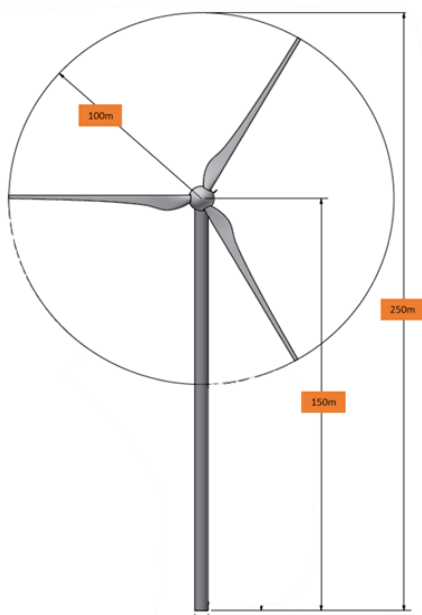

Figure 1-3: Turbine Specifications and Typical Components



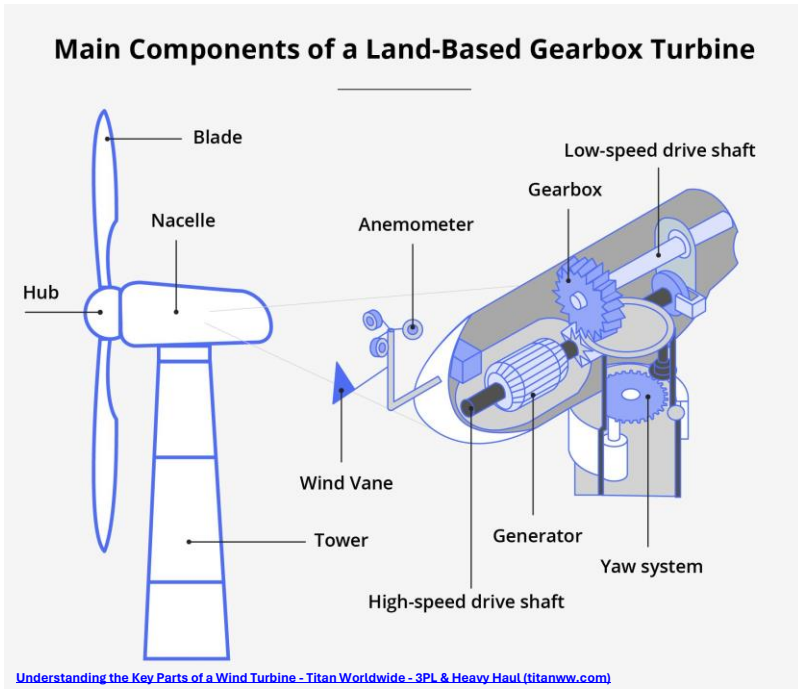

Figure 1-4: Key Parts of a Wind Turbine

Figure 1-5 shows the proposed layout of WTG's and associated infrastructure across respective land parcels for the Khoe WEF (Appendix B – WTG Layout Khoe WEF).

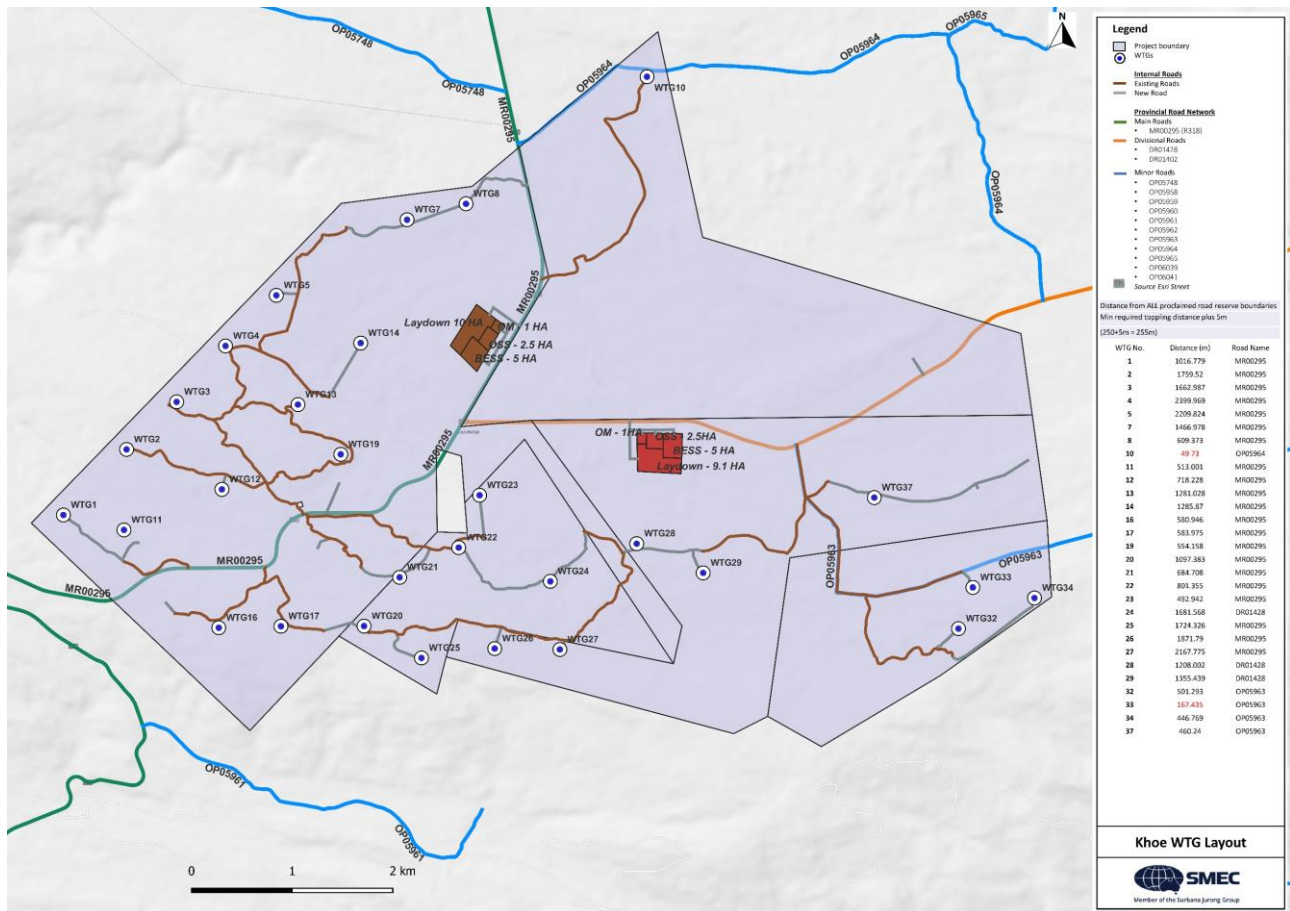

Figure 1-5: Proposed Khoe WEF Layout

## 1.4 Study Area

The extent of the study area covers key routes and intersections within a 10 km radius near the development on which the expected traffic generated by the development may have a significant impact. Thus, the following intersections were included in the study area:

1. Intersection 1: N1 (Beaufort west - Worcester) and R318 (Montagu);
2. Intersection 2: R318 and Road DR01442;
3. Intersection 3: R318 and Road OP05749;
4. Intersection 4: R318 and OP5748 (Road to Middleberg);
5. Intersection 5: R318 and DR01428 (Road to Nougaspoot); and
6. Intersection 6: R318 and OP05962 (Road to Keerom O/G Pad).

The surrounding land use and supporting road network hierarchy are outlined in the following section.

## 2 Status Quo

### 2.1 Land Use

The proposed Khoe WEF development site is situated mainly in agricultural land, with some natural and semi-natural vegetation. These activities are expected to continue during the construction, operation, and eventual decommissioning of the sites.

### 2.2 Surrounding Road Network

#### 2.2.1 Road Hierarchy

The road network in the immediate vicinity of the Khoe WEF development site is shown in Figure 2-1. The general location of the sites is made up of farmlands with rural unpaved Class 4 roads supporting movement between the various farms as well as access to some of these land parcels.

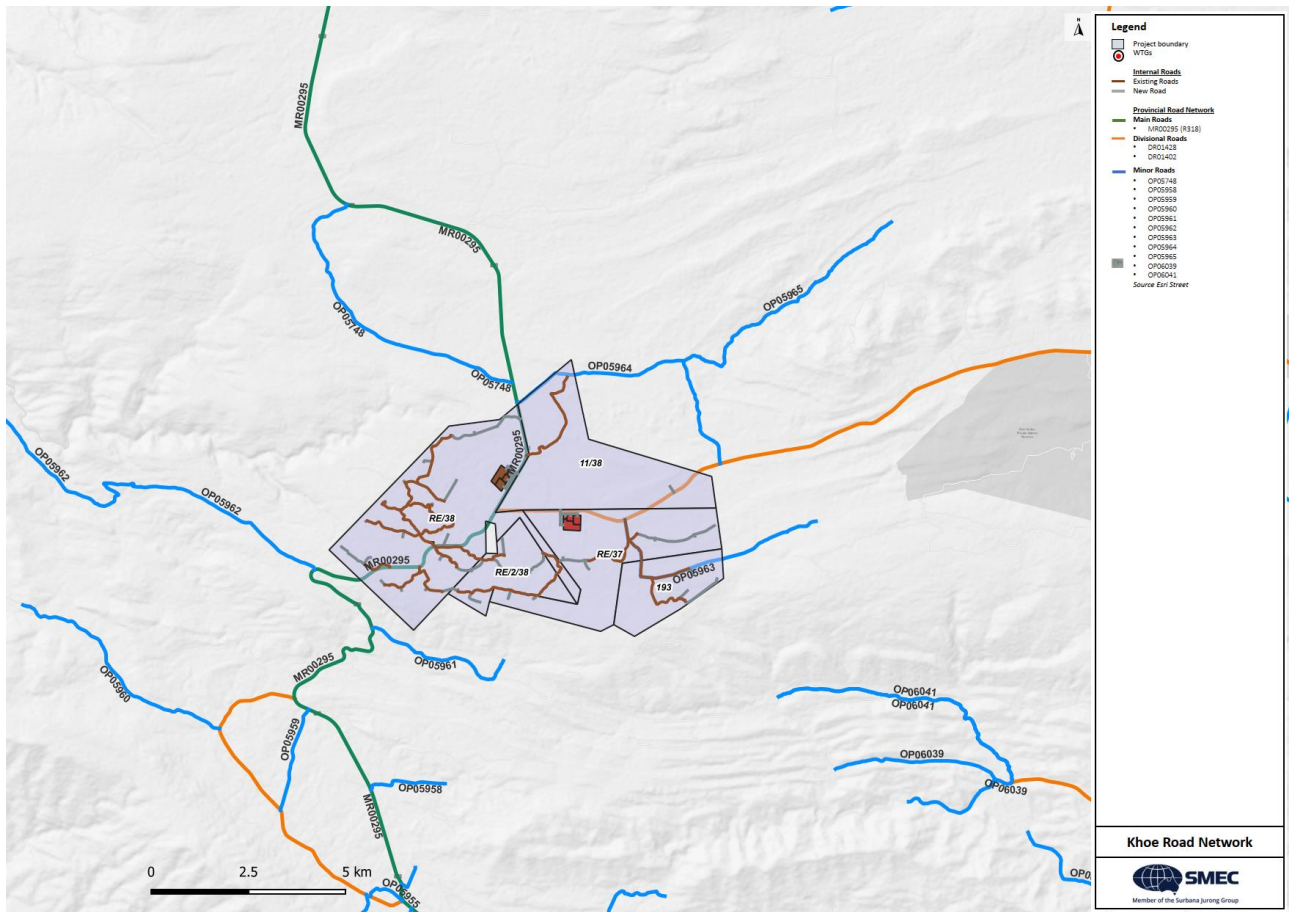

Figure 2-1: Road Network Hierarchy

The hierarchy of the road network in the immediate vicinity of the development site is shown in Appendix C – Existing Surrounding Road Network and summarised below.

- R318:** R318 is a Class 3 Provincial Main Road (MR00295) that runs in the north-south direction from the N1 near De Doorns through Montagu to R60 near Ashton. The R318 road passes through the Hex River Valley, which is known for its vineyards, fruit farms, and scenic views. The R318 road has a general posted speed limit of 100 km/h and connects to the R62 road, which is a popular tourist route that links Cape Town and Port Elizabeth. The length of R318 in kilometres is 77.4km (Start: Jct N1 De Doorns, End: Montagu);



- **Road OP05748:** Road OP05748 is a Class 5 Provincial Minor Road (gravel access road) which is located to the west of Main Road R318 (MR00295). The length of OP05748 in kilometres is 7.42 km (Start: Jct MR295 on Zout Riviers Berg, End: Property 171 Ezeljagt & 7 De B);
- **Road OP05964:** Road OP05964 is a Class 5 Provincial Minor Road (gravel access road) which is located to the east of Main Road R318 (MR00295). The length of OP05964 in kilometres is 7.55 km (Start: Jct MR295 on Eendragt 38, End: Jct DR1248 on De Braak 7);
- **Road DR01428:** Road DR01428 is a Class 4 Provincial Divisional Road (gravel road) which runs in the east west direction to the east of Main Road R318 (MR00295). The length of Road DR01428 in kilometres is 19.5 km (Start: Jct MR295 Sandvlei, End: Jct DR1411 Nougaspoort);
- **Road OP05963:** Road OP05963 is a Class 5 Provincial Minor Road (gravel access road), which is located to the south of Road DR01428. The length of OP05963 in kilometres is 6.48 km (Start: Jct DR1428 Eendragt 37, End: Lopenderivier); and
- **Road OP05962:** Road OP05962 is a Class 4 Provincial Minor Road (gravel road) which is located to the west of Main Road R318 (MR00295). The length of OP05962 in kilometres is 11.95 km (Start: Jct MR295 Rooihoogste Pass, End: Keerom Boundary Witwater).

## 2.2.2 Key Intersections

Key intersections within the study area summarised below in terms of the junction configuration and control. Current conditions of these intersections are indicated in Appendix D – Existing Intersections.

- Intersection 1: N1 (Beaufort west - Worcester) and R318 (Montagu);
  - 4-Way Junction;
  - N1 main road with right of way in the east-west direction;
  - R318 minor side road (south) with a stop control;
  - Private access road (north) with a stop control; and
  - Intersection configuration consists of a single lane in the north-south direction, a single lane in the east approach/exit direction and two lanes in the west approach/exit direction comprising of one full lane and an accommodative 120 m passing lane eastbound.
- Intersection 2: R318 and Road DR01442;
  - T-Junction;
  - R318 main road with right of way in the north-south direction;
  - Road DR01442 Matroosbergstasie minor side road (west) with a yield control; and
  - Intersection configuration consists of a single lane in each direction.
- Intersection 3: R318 and Road OP05749;
  - T-Junction;
  - R318 main road with right of way in the north-south direction;
  - Road OP05749 forms an access-controlled minor side road (east); and
  - Intersection configuration consists of a single lane in each direction.
- Intersection 4: R318 and Road OP05748;
  - T-Junction;
  - R318 main road with right of way in the east-west direction;
  - Road OP05748 forms access-controlled minor side road (west); and
  - Intersection configuration consists of a single lane in each direction.
- Intersection 5: R318 and Road DR01428;

- T-Junction;
- R318 main road with right of way in the north-south direction;
- Road DR01428 forms a minor side road (east) with a stop control; and
- Intersection configuration consists of a single lane in each direction.
- Intersection 6: R318 and Road OP05962;
  - T-Junction;
  - R318 main road with right of way in the north-south direction;
  - Road OP05962 forms a minor side road (west) with a stop control; and
  - Intersection configuration consists of a single lane in each direction.

## 2.3 Data Collection and Traffic Volumes

### 2.3.1 Current Traffic Volumes

To understand the effects of additional traffic on the road network, an understanding of existing road network traffic conditions is required. Thus 12-hour manual classified traffic counts were conducted at four (4) key intersections which are outlined in Section 2.2 above. These traffic counts were carried on Monday, 15 April 2024 between 06h00-18h00.

The volume of traffic on the Main Road R318 is relatively low compared to traffic volumes along the N1 National Road. Similarly, all other roads (Road DR01442, Road OP05749 and Road OP05748) carry significantly very low levels of traffic volumes compared to both Main Road R318 and the N1 National Road.

Traffic flow diagrams representing the 2024 existing traffic count data (total vehicles) are shown in Appendix E – Existing Traffic for the weekday AM peak hour, PM peak hour and 12-hour periods. Observed AM and PM peak hour volumes are summarised in Figure 2-2 below and occurred during the following periods:

- AM peak hour: 10h45 – 11h45; and
- PM peak hour: 16h00 – 17:00.

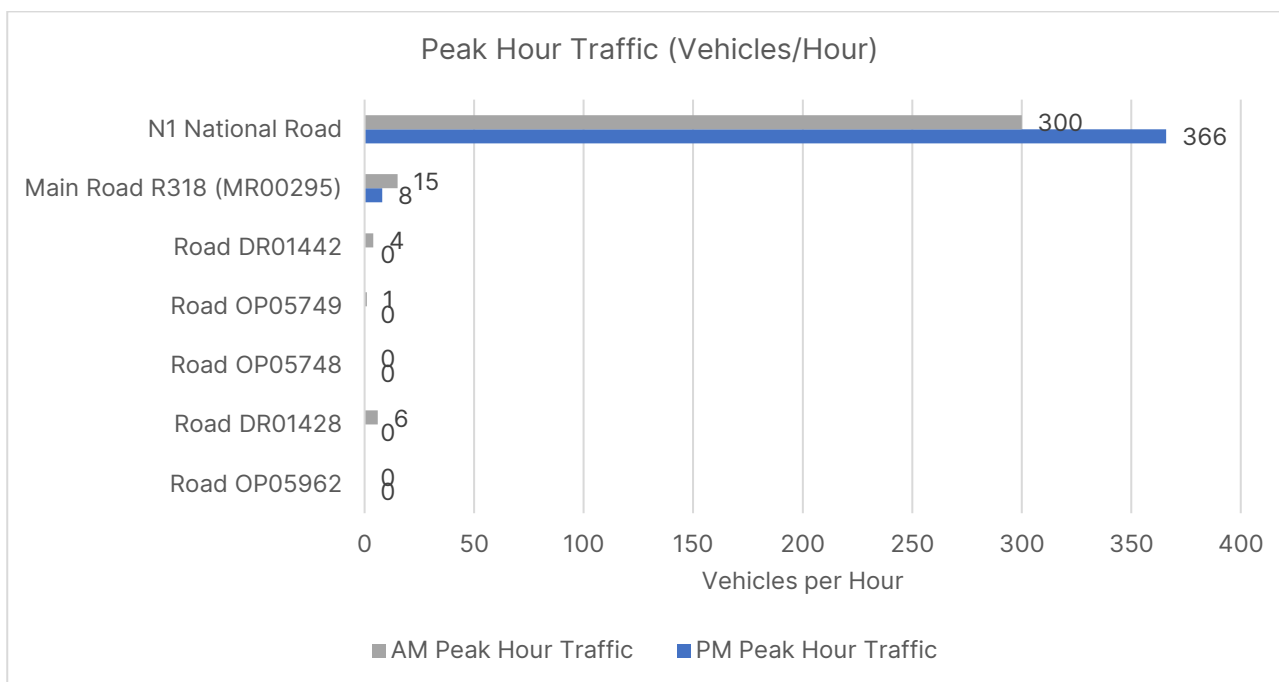

Figure 2-2: Road Network Peak Hour Traffic (vehicles per hour)

**N1 National Road:** 300 vehicles per hour and 366 vehicles per hour were recorded during the AM peak hour and PM peak hour, respectively, including 56 and 99 heavy vehicles during the respective peak hours.

**Main Road R318 (MR00295):** 15 vehicles were recorded during the AM peak hour and 8 vehicles were recorded during the PM peak hour. Only 2 heavy vehicles were recorded during the AM peak hours and 0 in the PM peak hour.

**Road DR01442:** A total of 4 vehicles including heavy vehicles were recorded during the AM peak hour and none during the PM peak hour.

**Road OP05749:** A single vehicle was recorded in the AM peak hour and none in the PM peak hour.

**Road OP05748:** There were no vehicles observed during peak periods on Road OP05748

**Road DR1428:** A very low traffic volume of 6 vehicles were recorded in the AM peak hour with no vehicles recorded in the PM peak hour.

**Road OP05962:** There were no vehicles observed during peak periods on Road OP05962.

### 2.3.2 Provincial Roads and SANRAL Counts

Additional traffic counts data sets sourced from the Western Cape Province’s Road Network Information System and the South African National Roads Agency Limited (SANRAL) were reviewed to develop an understanding of general traffic patterns along the surrounding major road network.

Projected traffic volumes to the current year as obtained from the Road Network Information System estimated an Annual Average Daily Traffic (AADT) of 248 AADT on Main Road R318 and 52 AADT on Divisional Road DR01442 with no record of traffic counting along all Minor Roads, Road OP05749 and Road OP05748.

There were no current year 2024 traffic volume counts from the SANRAL database, however, historical traffic data were only available for year 2019 and prior years and recorded an Average Daily Traffic (ADT) of 3772 to 4815 ADT on the N1 National Road within the vicinity of the site as observed from SANRAL CTO station 18018 and 18017, respectively.

Daily traffic volumes from the above two data sets are included in Appendix F – Provincial Roads and SANRAL Counts and are summarised in Table 2-1 in comparison to the 2024 12-hour surveys. Considering that approximately 30% ADT comprises of night traffic as per SANRAL station data, the short term 12-hour counts provide a reasonable representation of traffic flows within the study area.

Table 2-1: Typical 12-Hour and Daily Traffic Volumes

Road Name	12-Hour Counts (SMEC)	Projected Counts (AADT) (Western Cape Province)	Historical Counts (ADT) (SANRAL)
N1 National Road	3282-3295	N/A	3772-4815
Main Road R318 (MR00295)	124-194	248	N/A
Divisional Road DR01442	21	52	N/A
Minor Road OP05749	2	N/A	N/A
Minor Road OP05748	2	N/A	N/A
Road DR1428	34	38	N/A
Road OP05962	1	N/A	N/A

*N/A – means counts not undertaken by the road authority and/or the authority is not the responsible road authority*



### 2.3.3 Non-Motorised Transport and Public Transport

The roads surrounding the development site can be categorised as rural roads with no provision for non-motorised transport (NMT) and public transport (PT) facilities as the demand is very low. Thus, there are no formalised pedestrian and public transport facilities on the surrounding road network.

The following summary indicates the total number of buses and minibus taxis observed along the N1 National Road and Main Roads R318 (MR00295) during the 12-hour counting period:

- N1 National Road:
  - 32 Buses; and
  - 11 Minibus Taxis.
- Main Road R318 (MR00295):
  - 1 Bus; and
  - 3 Minibus Taxis.

## 3 Development Layout

### 3.1 Planning Guidelines

The proposed Khoe WEF development falls outside of an urban area, thus as per the Western Cape Provincial Transport Infrastructure Act, 2023, the following building lines and building restriction areas with respect to provincial roads apply:

- (a) On each side of the road or railway line within a distance of 95 metres from the centre line, measured at right angles to the centre line of the road or railway line; and
- (b) Within a distance of 500 metres from any point of intersection of the centre line of such road.

In addition to the above requirements, the Western Cape Province Roads Authorities have previously imposed/recommended a minimum offset distance (from nearby roads) of tip height of WTG's plus 5 m to guard against toppling failure of WTG structures onto nearby public roads. Thus, the following minimum distances of structure location from the nearest provincial road reserve are preferred:

- 250 m (tip height) +5 m = 255 m.

The arrangement of the overall project infrastructure is indicated in Appendix G – Building Lines in relation to the above requirements and outlined in the following subsections.

### 3.2 WTG Layout

All other WTG structures except WTG 10 are located at acceptable distances from the 95 m building restriction line relative to adjacent provincial roads as summarised in Table 3-1.

All WTG structures are located at a distance greater than 500 m from centrelines of intersecting provincial roads as summarised in Table 3-2.

WTG 10 and WTG 33 are located at an offset distance of less than 255 m from nearby provincial roads as summarised in Table 3-3. Relocation of these three WTGs is necessary to achieve an acceptable offset distance from the affected provincial roads. Thus, it is recommended that WTG 10, WTG 38, and WTG 33 be shifted by the following offset distances from their current proposed positions:

- Additional 190 m for WTG 10 from the current position away from Road OP5964; and
- Additional 85 m for WTG 33 from the current position away from Road OP5963.

Table 3-1: WTG positions relative to adjacent provincial road centre line

Provincial Road	95 m Building Line
Minor Road OP5964	Closest WTG 10 is located +65 m (< 95 m)
Minor Road OP5963	Closest WTG 33 is located +173 m (> 95 m)

Table 3-2: WTG positions relative to adjacent intersecting centre lines of provincial roads

Intersection of Provincial Roads	500 m Building Line
Main Road R318 (MR00295) and Minor Road OP5964	Closest WTG 8 is located +790 m (> 500 m)
Main Road R318 (MR00295) and Divisional Road DR01428	Closest WTG 23 is located +745 m (> 500 m)
Divisional Road DR01428 and Minor Road OP5963	Closest WTG 37 is located +930 m (> 500 m)

Table 3-3: WTG positions relative to toppling offset distance from adjacent provincial road reserves

Provincial Road	Structure height (tip height) 250 m + 5 m = 255 m
Minor Road OP5964	Closest WTG 10 is located +49 m (< 255 m)
Minor Road OP5963	Closest WTG 33 is located +156 m (< 255 m)

### 3.3 Associated Infrastructure

The preferred location of the associated WEF facility infrastructure and alternative location of the associated WEF facility infrastructure within the development site has been assessed in relation to their proximities to the centrelines of adjacent provincial roads (Main Road R318 and Divisional Road DR01428) and the nearest intersecting provincial roads (Intersection of Main Road R318 and Divisional Road DR01428, Intersection Divisional Road DR01428 and Minor Road OP05963).

Appendix G – shows the proposed layout of the associated WEF facility infrastructure relative to the surrounding road network.

The preferred location of the associated WEF facility infrastructure which is located to the east of Main Road R318 (MR00295) complies fully with the requirements of building lines and building restriction areas, thus satisfying the minimum requirements as indicated in Table 3-4. These WEF infrastructure facilities are located at a distance greater than 140 m (> 95 m) from Main Road R318 and at a greater distance of at least 515 m (> 500 m) from the intersection of Main Road R318 and Divisional Road DR01428 which is located to the south.

Similarly, the alternative location of the associated WEF facility infrastructure which is located to the south of Divisional Road DR01428 complies fully with the requirements of building lines and building restriction areas, thus satisfying the minimum requirements as indicated in Table 3-5. These WEF infrastructure facilities are located at a distance greater than 115 m (> 95 m) from Divisional Road DR01428 and at a greater distance of at least 1142 m (> 500 m) from the intersection of Divisional Road DR01428 and Minor Road OP5963.

Table 3-4: Preferred Associated Infrastructure

Preferred Associated Infrastructure and Extent/Footprint Area (ha)	95 m Building Line (Road)	500 m Building Line (Intersection)
On-Site Substation (OSS): up to 2.5 ha	+140 m > 95 m	750 – 975 m
Operations and Maintenance (O&M building) with parking: up to 1 ha	+140 m > 95 m	930 – 1065 m
Battery Energy Storage System (BESS): up to 5 ha	+140 m > 95 m	510 – 855 m
Laydown areas (Permanent and Construction Areas): up to 9 ha	+235 m > 95 m	655 - 1170 m

Table 3-5: Alternative Associated Infrastructure

Alternative Associated Infrastructure and Extent/Footprint Area (ha)	95 m Building Line (Road)	500 m Building Line (Intersection)
On-Site Substation (OSS): up to 2.5 ha	+120 m > 95 m	1335 - 1500 m
Operations and Maintenance (O&M building) with parking: up to 1 ha	+115 m > 95 m	1500 - 1595 m
Battery Energy Storage System (BESS): up to 5 ha	+120 m > 95 m	1142 - 1335 m
Laydown areas (Permanent and Construction Areas): up to 9 ha	+225 m > 95 m	1160 - 1610 m

The alternative site is therefore recommended for Environmental Authorisation for the development:

- The alternative site is located directly next to a lower order Class 4 road (DR01428) where access is the predominant function;
- There are less than 20 vehicles per direction currently along DR01428.

## 4 Access Planning

### 4.1 Main Access Points

The site location and layout are such that two primary roads potentially provide access to the proposed Khoe WEF development being the Main Road R318 (MR00295) and Divisional Road DR01428. Thus, the proposed locations of providing main access to the development are from the existing intersections and accesses off Main Road R318 (MR00295).

Positions of 8 proposed accesses to the site off Main Road R318 (MR00295) are shown in Figure 4-1 and comprises of 5 existing farm accesses with 3 new access locations (1,2 and 3) which connect to new internal roads providing access to the associated WEF facility infrastructure located to the west and east of Main Road R318 (MR00295).

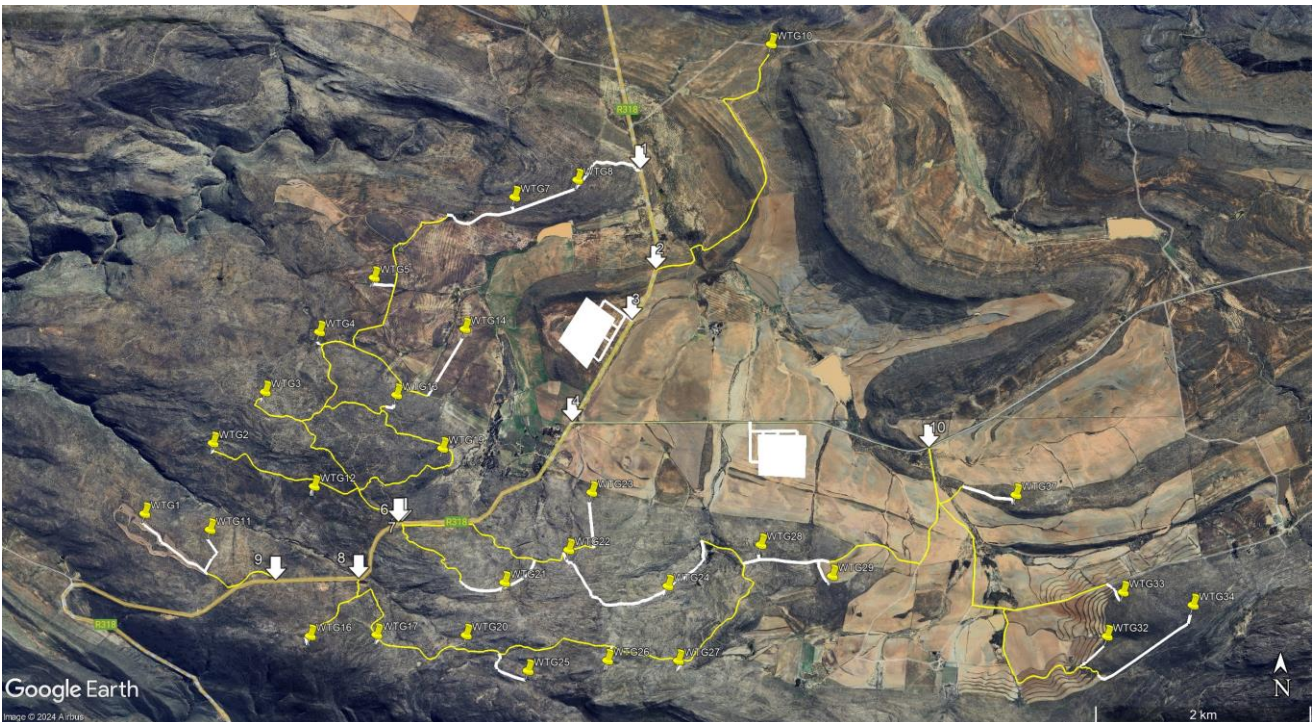



Figure 4-1: Proposed Access Locations (Source: Google Earth Pro)

Proposed site access locations, access spacing, and illustrations of current access conditions are summarised in Table 4-1.



Table 4-1: Existing and Proposed Accesses

Access Location and Access Spacing	Current Access Condition
<p>Proposed Access 1</p> <ul style="list-style-type: none"> <li>• New access</li> <li>• 450 m from intersection R318 &amp; OP05964</li> <li>• East of Main Road R318</li> <li>• Between KM 23 – KM 24 of Main Road R318</li> <li>• 950 m north of proposed Access 2</li> </ul>	
<p>Proposed Access 2</p> <ul style="list-style-type: none"> <li>• New access</li> <li>• East of Main Road R318</li> <li>• Between KM 23 – KM 24 Main Road R318</li> <li>• 500 m north of proposed Access 3 (preferred associated infrastructure access)</li> </ul>	
<p>Proposed Access 3</p> <ul style="list-style-type: none"> <li>• New access</li> <li>• West of Main Road R318</li> <li>• Between KM 24 – KM 25 Main Road R318</li> <li>• 1.1 km north of proposed Access 4 (Intersection of Main R318 and DR01428)</li> </ul>	
<p>Proposed Access 4</p> <ul style="list-style-type: none"> <li>• Existing Intersection of Main R318 and DR01428</li> <li>• East of Main Road R318</li> <li>• Between KM 25 – KM 26 Main Road R318</li> <li>• 2.0 km north of proposed Access 6</li> </ul>	

<p>Proposed Access 6</p> <ul style="list-style-type: none"> <li>Existing access</li> <li>East of Main Road R318</li> <li>Between KM 27 – KM 28 Main Road R318</li> <li>34 m north of proposed Access 7</li> </ul>	
<p>Proposed Access 7</p> <ul style="list-style-type: none"> <li>Existing access</li> <li>East of Main Road R318</li> <li>Between KM 27 – KM 28 Main Road R318</li> <li>700 m north of proposed Access 8</li> </ul>	
<p>Proposed Access 8</p> <ul style="list-style-type: none"> <li>Existing farm access</li> <li>East of Main Road R318</li> <li>Between KM 27 – KM 28 Main Road R318</li> <li>750 m north of proposed Access 9</li> </ul>	
<p>Proposed Access 9</p> <ul style="list-style-type: none"> <li>Existing farm access</li> <li>West of Main Road R318</li> <li>Between KM 29 – KM 30 Main Road R318</li> <li>2.1 km north of Minor Road OP5962</li> </ul>	

Table 4-2: Proposed Access Spacing Evaluation

Access Spacing	TRH 26 Road Classification and Access Management Manual	Access Management Guidelines, 2020 (Western Cape Provincial Transport Department)
Access 1 to 2	0.95 km < 1.6 km: Noncompliant	0.95 km > 850 m: Compliant
Access 2 to 3	0.5 km < 1.6 km: Noncompliant	0.5 km < 850 m: Noncompliant
Access 3 to 4	1.1 km < 1.6 km: Noncompliant	1.1 km > 850 m: Compliant
Access 4 to 6	2.0 km > 1.6 km: Compliant	2.0 km > 850 m: Compliant
Access 6 to 7	0.034 km < 1.6 km: Noncompliant	0.034 km < 850 m: Noncompliant
Access 7 to 8	0.70 km < 1.6 km: Noncompliant	0.70 km < 850 m: Noncompliant

Access 8 to 9	0.75 km < 1.6 km: Noncompliant	0.75 km > 850 m: Compliant
Access 8 to Road OP5962	2.1 km > 1.6 km: Compliant	2.1 km > 850 m: Compliant

In accordance with TRH 26 Road Classification and Access Management Manual guidelines in Table 4-3, two access positions comply with the recommended access spacing of 1.6 km, while the remaining accesses are noncompliant.

However, 5 out of 8 accesses are compliant based on the minimum spacing guidelines as per the Access Guideline Manual, 2020 (Western Cape Provincial Transport) for a Class 3 road with posted speed limit of 100 km/h (See Table 4-4).

Table 4-3: Minimum Spacing Requirements for full intersections on Mobility Roads

Class	Rural	Urban signals(*)	Urban roundabouts and priority(*)
Class 1	8.0 km	n/a	n/a
Class 2	5.0 km	800 m ± 15%	800 m ± 15%
Class 3	1.6 km	600 m ± 20%	600 m ± 20%

(\*) These values can be halved for the leg of T-junctions and for one-way streets.

Table 4-4: Minimum spacing distances of driveways/public roads intersecting with through roads in rural roadside development environments

Class of continuous route	Operating speed km/h	Minimum spacing between a public road or driveway and another public road or driveway along a through route						
		Upstream functional distance			Downstream functional distance			Total spacing metres
		Perception-reaction distance metres	Deceleration distance to stop metres	Total upstream distance metres	Acceleration distance from stop metres	Taper distance metres	Total downstream distance metres	
Class 1 & 2	120	65	255	320	940	85	1 025	1 345
Class 3	100	55	205	260	490	70	560	820
Class 4	80	45	115	160	235	55	290	450
Class 5	60	35	65	100	120	40	160	260

## 4.2 Access Points to Respective WTG sites

Access to WTG sites and other project infrastructure components will be provided via existing internal farm gravel roads and tracks which will be upgraded to roads width of 4.5 m and road servitude of 13.5 m.

## 4.3 Primary Access Roads and Design Considerations

This section outlines design considerations for the proposed site access roads to the associated infrastructure. Primary site access roads will mainly fulfil the functional classification of a Class 4 & Class 5 Rural Roads. Reference has been made to the following standards and guidelines for providing access roads, amongst others:

- Road Access Guidelines, Western Cape Provincial Roads Department.
- Draft TRH 20 – Unsealed Roads: Design, Construction and Maintenance.

A detailed route survey must be undertaken to analyze the geometry of internal existing roads and the proposed alignment of new internal routes, in addition to obstacles on the horizontal and vertical alignment with reference to the expected abnormal vehicles and turbine components.

Design considerations outlined in this section are not considered in great details. Thus, detailed design (adapted to the prevailing conditions) of primary access roads and improvements must be completed by the Principal



Contractor once appointed and prior to construction. Examples of typical transportation are shown in Table 4-5: Design Vehicles and Expected Infrastructure.

### Design Considerations

- **Site access junction improvements**
  - Widening of site access intersections to provide temporary junction overrun areas to accommodate adequate turning radii for anticipated abnormal loads/vehicle sizes.
  - Clearing and grubbing of existing vegetation, removal of obstacles within the visibility junction splay areas to ensure sufficient lines of sight for vehicles using the access.
- **Geometric design (vertical and horizontal alignment)**
  - The maximum permissible longitudinal grade at the centreline of the primary access roads must consider limitations of the equipment which will transport the project components to high-lying areas (i.e., must account for the expected heavy vehicle performance characteristics and weight of turbine components).
  - Cuts and fills will be required to create suitable grades where necessary.
  - Road sections of primary access roads with insufficient turning radii will need to be widened to minimum radius of 60 m.
  - Adequate stopping sight distance for design vehicles - both passenger car and heavy vehicles.
- **Cross drainage and structural design**
  - Road drainage improvements along primary access roads at locations of minor water courses to accommodate construction vehicles during rainy reasons.
  - Provision of low-level structures, concrete drifts, cut-off walls, bridge structures or culverts where required.
  - The design of drainage structures must accommodate the relevant design flood return period.
  - The design of drainage structures must accommodate the load bearing capacity to carry anticipated loads (weight over structures).
- **Pavement design**
  - The pavement structure of must be designed to carry expected traffic loads.
  - Material selection, fractured stone, sand and fine particles with binding characteristics.
- **General**
  - Traffic Management and Safety - Road signage as per the South African Road Traffic Signs Manual and Reduction in vehicle speed
  - Design and Construction Standard Plans as per Western Cape Province, Department of Infrastructure included in Appendix G – .

Table 4-5: Design Vehicles and Expected Infrastructure

 <p>Figure 1.2: Abnormal Load on a Long Wheelbase Trailer</p>  <p>Figure 1.3: Self-Supporting Load on a Steerable Dolly</p>	<p><b>Guideline:</b>  <b>TRH 11 Dimensional and Mass Limitations and Other Requirements for Abnormal Load Vehicles</b></p>
	<p><b>Wind turbine components transported on roads in the Eastern Cape</b></p> <p>Motorists are hereby notified that today , the 19th of February 2024, wind turbine components will be transported as follows:</p> <ol style="list-style-type: none"> <li>At 07:00 3 x abnormal loads (3 x Blades) will be escorted by 6 Traffic vehicles from the Coega Harbour in Gqeberha, via N2 (Nanaga), N10 (Olifantskop Pass) towards Cookhouse. The Olifantskop Pass will be closed for 1 hour when the blades pass through it.</li> <li>At 07:00 3 x abnormal loads (3 x Blades ) will be escorted by 6 Traffic vehicles from the Coega Harbour in Gqeberha via Motherwell, through Kariega on the R75 towards Jansenville. We urge all road users to be patient and drive safely. Please expect delays in traffic.</li> </ol>
	<p><b>Wind turbine blades transported through the Olifantskop pass towards Cookhouse</b></p> <p>On Wednesday, 13 March 2024 at 07:00am, three abnormal loads (Blades) will be escorted by 6 Traffic vehicles from the Koega Harbour in Gqeberha, via N2 (Nanaga), through the Olifantskop pass towards Cookhouse. The Olifantskop Pass will be closed for approximately one hour when the blades pass through it.</p> <p>&amp;</p> <p>Tomorrow Wednesday, 13 March 2024 at 07:00 three abnormal loads (2 x Blades and 1 x Tower) will be escorted by 6 Traffic vehicles from the Koega Harbour in Gqeberha via Motherwell, through Kariega on the R75 towards Jansenville.</p>
	<p><b>Wind turbine blades transported on roads in the Eastern Cape</b></p> <p>According to reports several “Wind trucks” are traveling through Graaff-Reinet.They have travelled up from Coega and we assume they are on their way to the three Koruson 1 wind farm sites currently under construction outside Middelburg and Noupoort.</p> <p>Please BE PATIENT AND MOVE OUT OF THEIR WAY!“Turbine blades and other components for the project being transported from Coega port to the Koruson 1 wind farm sites outside Middelburg and Noupoort. The components, which will supply 26 turbines on three windfarms in the area, total 237 blades. Each blade is 81.35m long x 3.8 m high at rotor end x 5.0 m at the widest point, with a weight of 28 tons.”</p>
	<p><b>Four Nacelles of wind turbines transported on roads in the Eastern Cape</b></p> <p>Today, the 01st of March 2024 at 07:00, 4 abnormal loads (4 x Nacelles) will be escorted by a convoy of Traffic and routine road maintenance vehicles from the Coega harbour in Gqeberha, via Motherwell, though Kariega (Uitenhage) on the R75 towards Jansenville.</p> <p>(source: <a href="https://truckandfreight.co.za/">https://truckandfreight.co.za/</a>).</p>

## 4.4 Sight Distance Assessment

To gauge the suitability of the proposed accesses, sight distances were evaluated based on a desktop assessment study using digital elevation modelling (DEM), viewshed analysis, to determine sight distances. Available sight distances are summarized in Table 4-6 with reference to the safe stopping sight distance criteria in Figure 4-2. The digital elevation model results are shown in Appendix I – Sight Distance Assessment and indicates all points on the main road which are visible from a specific access point.

Sight distances were assessed based on the expected largest vehicle which represents the worst-case scenario. Thus, the primary typical vehicle configuration that was considered was a Single Unit Truck (crossing a road width of 7,5 m) which would access the development mainly during the construction phase through Main Road R318 (MR00295) from stop-controlled minor roads/access roads.

Table 4-6: Sight Distance Assessment

Proposed Access	Posted Speed on R318	Required Sight Distance	Measured Sight Distance (Left)	Measured Sight Distance (Right)	Comply Left	Comply Right
Access 1	100 km/h	380 m	1640 m	200 m	Y	Y
Access 2	100 km/h	380 m	220 m	950 m	N	Y
Access 3	100 km/h	380 m	418 m	1700 m	Y	Y
Access 4	100 km/h	380 m	455 m	1600 m	Y	Y
Access 6	100 km/h	380 m	230 m	150 m	N	N
Access 7	100 km/h	380 m	180 m	220 m	N	N
Access 8	100 km/h	380 m	180 m	500 m	N	Y
Access 9	100 km/h	380 m	1600 m	260 m	Y	N
Access 10	60 km/h	225 m	110 m	1700 m	N	Y
Access 11	60 km/h	225 m	400 m	230 m	Y	Y

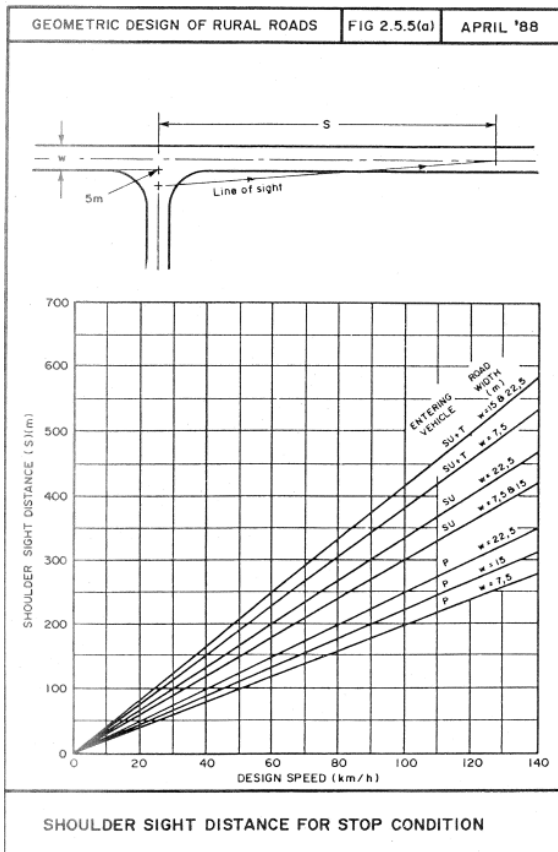

Figure 4-2: Shoulder Sight Distance for Stop Condition



Based on the sight distance assessment, it should be noted the terrain is rolling in nature providing limited opportunities for an access point that meets sight distance requirements in both directions. The vertical profile of the Main Road (MR00295) along the proposed site access consist of a rolling terrain with average gradients in the region of -1% to 7%. In light of the above, it is recommended that the proposed accesses be approved based on the following points:

1. Heavy vehicles in the form of articulated trucks are only expected during the construction phase of the development. The largest heavy vehicle expected during the operational phase is a single unit truck;
2. The Main Road R318 carries very low traffic volumes in peak hours (less than 20 vehicles) and less than 50 vehicles per day thus demand on the main road will mostly comprise of development site traffic;
3. The arrival and departure of construction/ decommissioning vehicles should be staggered during off- peak periods to ensure a reduced impact during low volume traffic periods;
4. The Project Manager and Site Safety Officer should, during construction and decommissioning, ensure correct signage and safety precautions are in place for vehicles and pedestrians on-site and at the site access. These should include temporary regulatory signs such as speed prohibition signs, warning signs (slow moving heavy vehicle, construction vehicle crossing signage) and flagmen and appoint traffic officials in managing traffic on the access road when abnormal loads are being moved to ensure traffic law enforcement; and
5. Adequate turning radii at access points should be provided to accommodate and allow for the safe turning manoeuvre of the expected articulated vehicles.

## 5 Transportation Route

### 5.1 Port of Entry

It is anticipated that some wind turbine components and equipment, including blades and nacelles, for construction and operation of the WEF will be imported through seaports. There are three seaports in the Western Cape which are operated by Transnet National Ports Authority that could be used for the delivery of turbine components and equipment:

- Port of Cape Town;
- Port of Mossel Bay; and
- Port of Saldanha Bay.

Each seaport has its own advantages and disadvantages, depending on the type, size, and quantity of the equipment, as well as the distance, cost, and availability of the transport services. In considering possible routes to be used to transport abnormal loads, the following factors were considered:

- Avoidance of large cities and towns;
- Distance from the port of entry to the development site;
- Availability of high order roads to be used to haul abnormal loads; and
- Mountain passes which present challenging vertical curve profile and horizontal curve alignment for the expected abnormal heavy vehicles and loads.

It is recommended that a full route determination study should be completed and appropriate approvals from relevant authorities should be obtained before abnormal vehicles are finally routed.

## 5.1.1 Route Option 1 from Port of Cape Town

This is a 190 km journey route from the Port of Cape Town to site (See Figure 5-1). The greater extent of this route comprises of the N1 National Road which is ideal for hauling abnormal loads as generally National roads are of high quality and many of the structures have been assessed for load bearing capacity and height clearance. However, this route passes through the Huguenot Tunnel and the Hexrivier Pass which may present logistical challenges given the nature of the abnormal loads being transported. The height of the tunnel in comparison to the height of the load as well as other potential constraints the route will have to be assessed at a later stage by a competent professional to be appointed to design the hauling route to be used for abnormal deliveries.

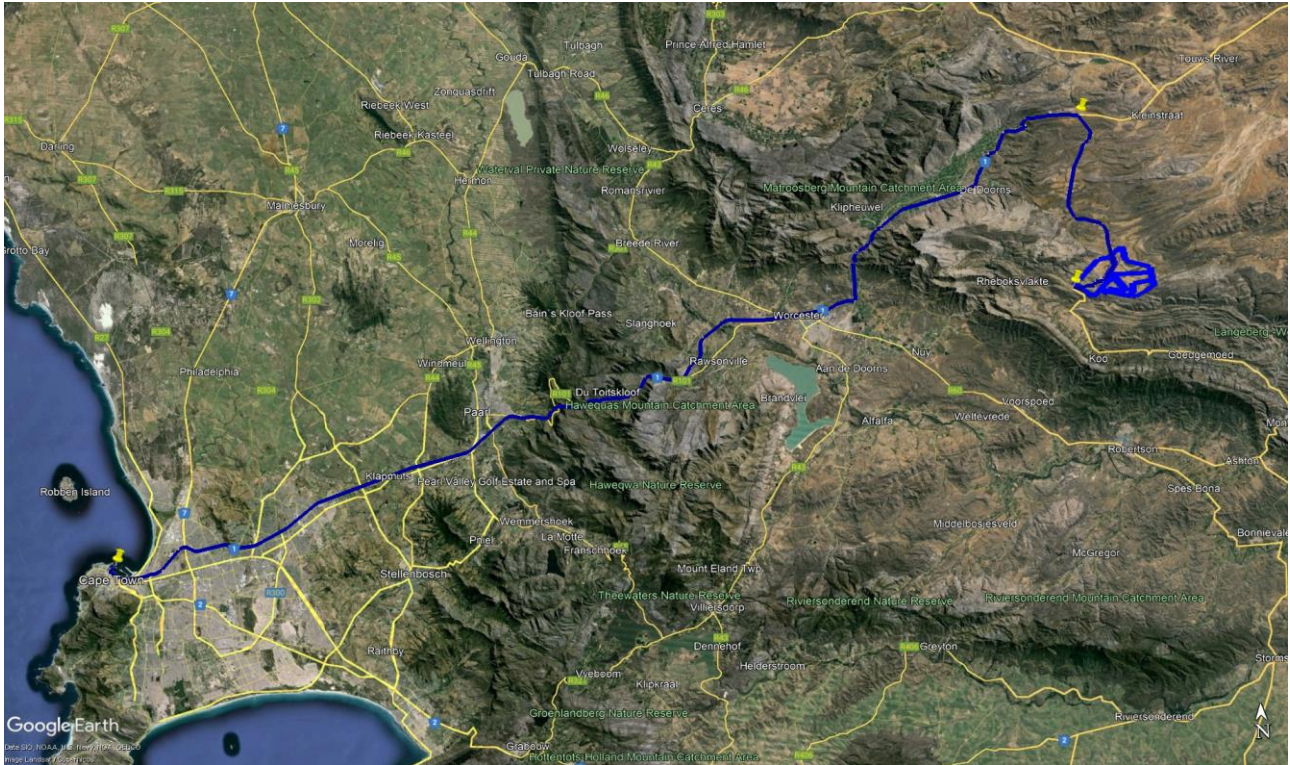

Figure 5-1: Option 1 Route (Source: Google Earth Pro)

The route is narrated as follows:

### Follow S Arm Rd and Dock Rd to Nelson Mandela Blvd/N1/N2

1. Head southwest toward S Arm Rd
2. Turn left onto S Arm Rd
3. Turn right to stay on S Arm Rd
4. At the roundabout, continue straight to stay on S Arm Rd
5. Continue onto Dock Rd

### Follow N1 to R318

6. Use the left 3 lanes to turn left onto Nelson Mandela Blvd/N1/N2 (signs for Paarl/Cape Town International Airport/Somerset)
7. Keep left to continue on N1, follow signs for Paarl/Bellville/R27/Milnetron
8. Continue straight to stay on N1
9. Turn right onto R318
10. Turn right onto R318;



## 5.1.2 Route Option 2 from Port of Mossel Bay

This is a 281 km journey route from the Port of Mossel Bay to site. A significant section of this journey is completed on the N2 National Road, with lower class roads such as the R60, R62 and R318. Mossel Bay and Swellendam are the two major towns the route traverses (See Figure 4 2). The suitability of mountain pass found on this route, Burgerspas, Rooihoogstepas, Kogmanskloofpas, will have to be assessed at a later stage by a competent professional to be appointed to design the hauling route to be used for abnormal deliveries.

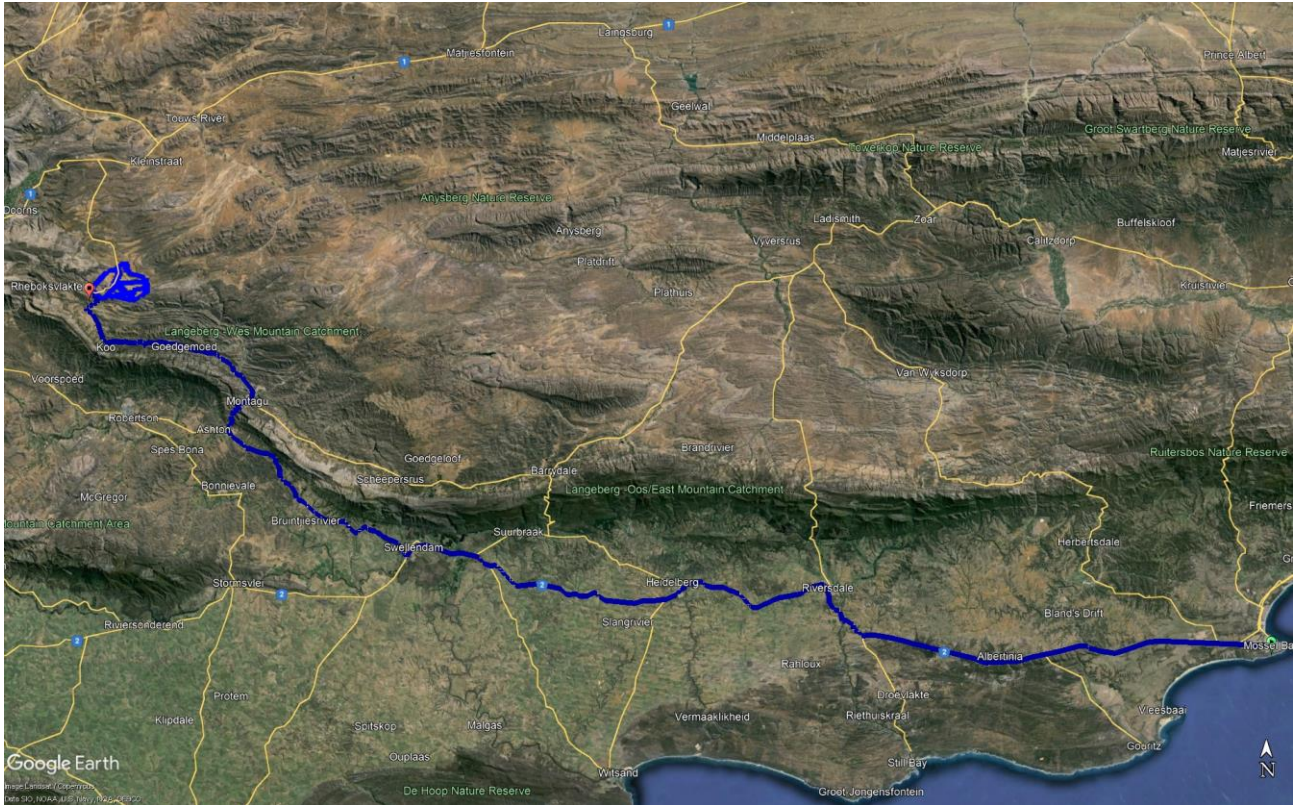

Figure 5-2: Option 2 Route (Source: Google Earth Pro)

The route is narrated as follows:

1. Head west on Louis Fourie Rd/R102 toward Louis Fourie Rd/R102;
2. Continue onto N2;
3. Turn right onto R60;
4. Turn right onto R62;
5. Turn left onto Cross St/R318;
6. Turn right at the 1st cross street onto Bath St/Main Rd/R318;



### 5.1.3 Route Option 3 from Port of Saldanha Bay

This is a 261 km journey route from the Port of Saldanha Bay to the proposed Khoe WEF site. It comprises of high order and lower order routes through rural towns and farming communities (See Figure 5-3). Several mountain passes namely, Nuwekloofpas, Michell's Pass, Theronbergpas and Molteno Pass are found along this route. The feasibility of hauling abnormal loads through this route will have to be verified at a later stage by a competent professional to be appointed to develop the transportation solution.

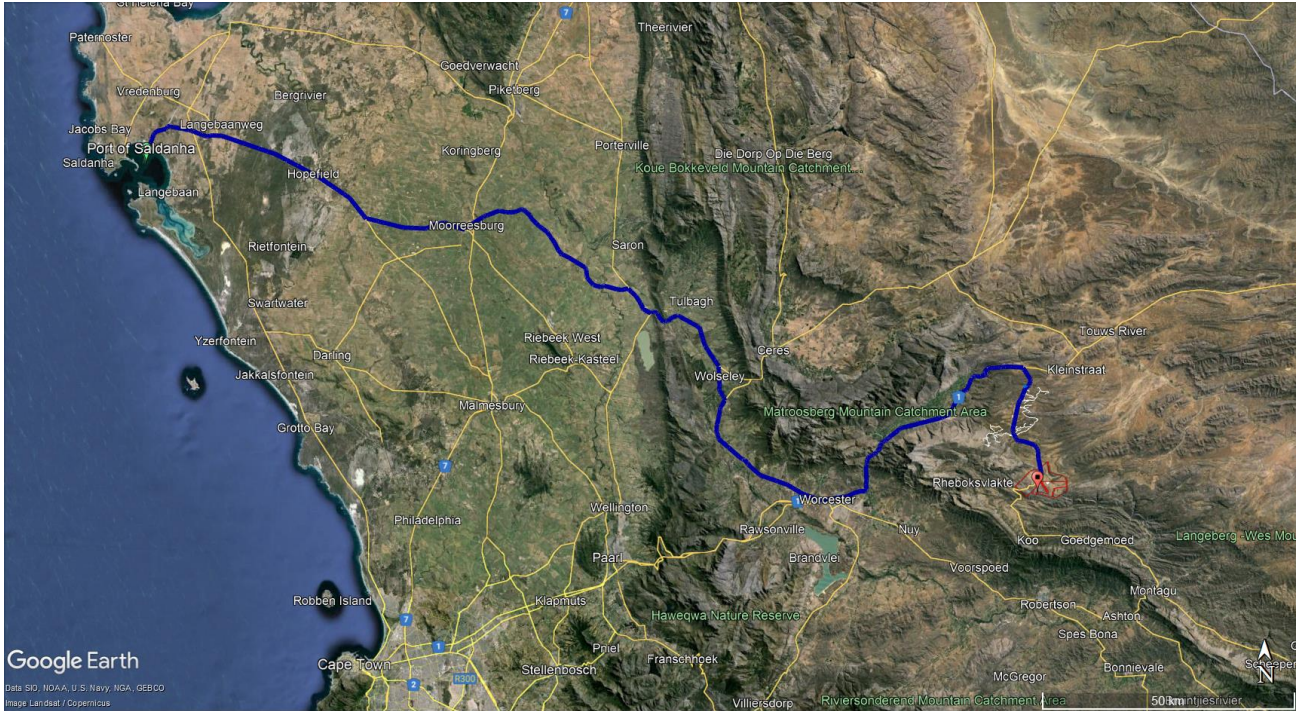

Figure 5-3: Option 3 Route (Source: Google Earth Pro)

The route is narrated as follows:

**Take Harbour Rd to Saldanha Rd (3 min: 1.3 km)**

1. Head southeast
2. Slight left
3. Turn left onto Harbour Rd

**Drive from Main Rd/R399 to West Coast Peninsula (8 min: 7.5 km)**

4. Harbour Rd turns right and becomes Saldanha Rd
5. Continue onto Main Rd/R399
6. At the roundabout, take the 1st exit and stay on Main Rd/R399

**Continue to R45 (13 min: 18.7 km)**

7. Turn right at Jacobsbaai Rd;
8. Continue onto Saldanha Steel Langebaan;
9. Continue onto TR8501;
10. Continue straight;

**Continue on R45 to Moorreesburg (31 min:53 km)**

11. Continue onto R45;
12. Turn left onto R311;

**Follow Gouda Rd to R44 (33 min: 40.8 km)**

13. Turn left onto Main St;
14. Continue onto Piketberg Rd;
15. Continue straight onto Gouda Rd;

**Take R46, R43 and N1 to R318 (1 hr 25 min: 121 km)**

16. Turn right onto R44;
17. Turn left onto R4;
18. Turn right onto Voortrekker S;
19. Turn right onto R43;
20. Continue straight to stay on R43;
21. Turn left onto N1/R43;
22. Continue straight to stay on N1;
23. Turn right onto R318;

# 6 Identification of Transport Impact

## 6.1 Trip Generation

The trips generated at the Karoo WEF will vary during the different phases of project implementation. Project phases are usually defined as follows:

Pre-construction	Construction	Operational	Decommissioning	Closure
<ul style="list-style-type: none"> <li>•Site survey and preparation</li> </ul>	<ul style="list-style-type: none"> <li>•All construction and installation related activities until contractor leaves the site such as component, equipment and material truck deliveries.</li> </ul>	<ul style="list-style-type: none"> <li>•All activities after construction and installation of WEF, such as operation, maintenance and other services related activities.</li> </ul>	<ul style="list-style-type: none"> <li>•Withdrawal and site rehabilitation</li> </ul>	<ul style="list-style-type: none"> <li>•Closure of site</li> </ul>

Figure 6-1: Project Phases

Generally, Wind Energy Facilities generate traffic during three phases or categories, namely:

- Phase 1: Construction Traffic;
- Phase 2: Operation Traffic; and
- Phase 3: Decommission Traffic.

### 6.1.1 Construction Phase Traffic

The construction phase traffic can be attributed to two aspects, namely:

- Material and equipment delivery; and
- Transportation of labour.

#### 6.1.1.1 Material and Equipment Delivery

Trips generated during the construction phase will primarily comprise of transporting equipment, turbine components, personnel, construction, and other facility materials comprising of normal, heavy, and abnormal load vehicles. It is expected that the construction phase will have the highest traffic impact of all the phases. The following assumptions were made to calculate trips generated during the construction phase.

- It was estimated that the construction period will last approximately 2 years with a 5-day working week resulting in 480 working days over 24 months.
- The Khoe WEF will most likely be constructed from components that will need to be shipped to South Africa via the preferred seaport and be transported to site via road transportation using heavy and abnormal load vehicles. It is also assumed that the turbine component delivery period will be over a course of consecutive 9 months.
- Different abnormal vehicle options, similar to the ones listed in Figure 6-2 to Figure 6-5, as found in the TRH11 (2009), may be selected depending on the logistic service provider used to transport wind turbine components. The remainder of the facility components and construction equipment will use standard transport vehicles and therefore will not require abnormal vehicles.



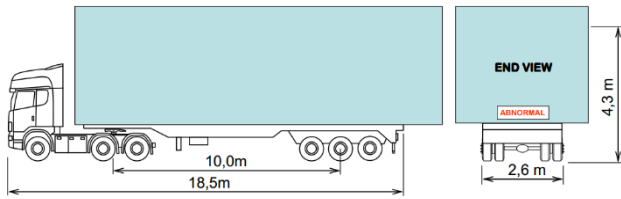

Figure 6-2: Abnormal Load on a Legal Combination

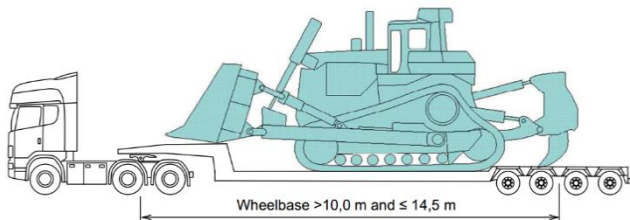

Figure 6-3: Abnormal Load on a Long Wheelbase Trailer

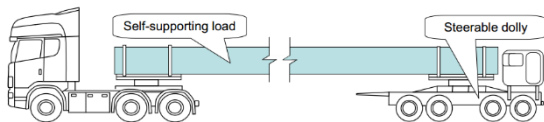

Figure 6-4: Self-Supporting Load on a Steerable Dolly



Figure 6-5: Heavy Loads on Multi-axle or Modular Trailers

- Wind Turbine components and associated details as provided by the client are presented in Table 6-1.

Table 6-1: WEF Components to be transported

Component	Details	Comments and Assumptions
Tower	Length: 150 m	3 Tower sections/WTG Abnormal vehicle required to transport component
Rotor	Blade Length: 100 m	3 Blades/WTG Abnormal vehicle required to transport component
Hub	Weight: Varies 7 to 14 tons	1 Hub Securing 3 Blades/WTG Abnormal vehicle required to transport component
Nacelle	Weight: 68.3 tons	1 Nacelle/WTG Abnormal vehicle required to transport component
WTG Foundation (assumption)	Foundation depth: 5 m Diameter 30 m Volume of concrete: 1885 m <sup>3</sup>	Reinforced Concrete Heavy vehicle to transport materials

Crane Platform and Hard Stand Areas	Area: 1 ha (10000m <sup>2</sup> )	Levelled and compacted Heavy vehicle to transport materials
Electrical Cabling	33 kV Electrical network Underground/ Overhead	Concrete, steel or wood monopoles Guy line supported steel structures Free standing metal lattice towers; or Multi-pole structures such as H-towers or K-towers. Heavy vehicle to transport materials
	132 KV	Lattice Steel Pylons Cables, Connectors and Transformers; and Normal load vehicle to transport
Switching Station	Area: 2.5 ha (25000 m <sup>2</sup> )	Transformers Switch gear O&M buildings (1 ha) Control rooms, grid control yards Heavy vehicle to transport materials

- Average “component per turbine” rate of 8 will be used (sum of abnormal components per WTG), therefore over the course of the turbine component delivery period, a maximum of approximately 232 abnormal vehicle loads to construct 29 Wind Turbines, will be delivered to the project site.
- 90 truckloads per Wind Turbine for road layer works will be delivered to the site (2610 truckloads for the project).
- Water for construction purposes (e.g., mass earthworks, dust suppression and roads) will be transferred from the source to the point of use on the site via tanker. Assume that 1 tanker will make two round trips per day (one round trip at the start and one round trip at the start end of the day). Expected water demand: ±24500m<sup>3</sup>, Assumption: 14m<sup>3</sup> Capacity (single water tanker truck)
- Some of the aggregate required for the construction of the on-site tracks may be sourced from cut and fill operations within the site with additional material be obtained from borrow pits or imported from quarries as required.
- 30 trips per Wind Turbines for construction, crane vehicles, switching gear and other substation equipment.

**6.1.1.2 Transportation of Labour**

Another contributor to trips generated to the site will be daily commuters/workers expected during construction. It has been assumed that a total labour force of approximately 255 workers will be required during construction. The majority of the labour force is expected to be sourced from towns in close proximities such as De Doorns, Worcester, Touws River with the remainder coming from other areas such as Montagu.

It is further assumed that approximately 55% of the labour force will be made up of low skilled workers (labourers, security), 30% semi-skilled (professional drivers – drive cars and light duty trucks on site) and 15% skilled personnel (engineers and technicians). The breakdown of the labour is anticipated as shown in Figure 6-6.

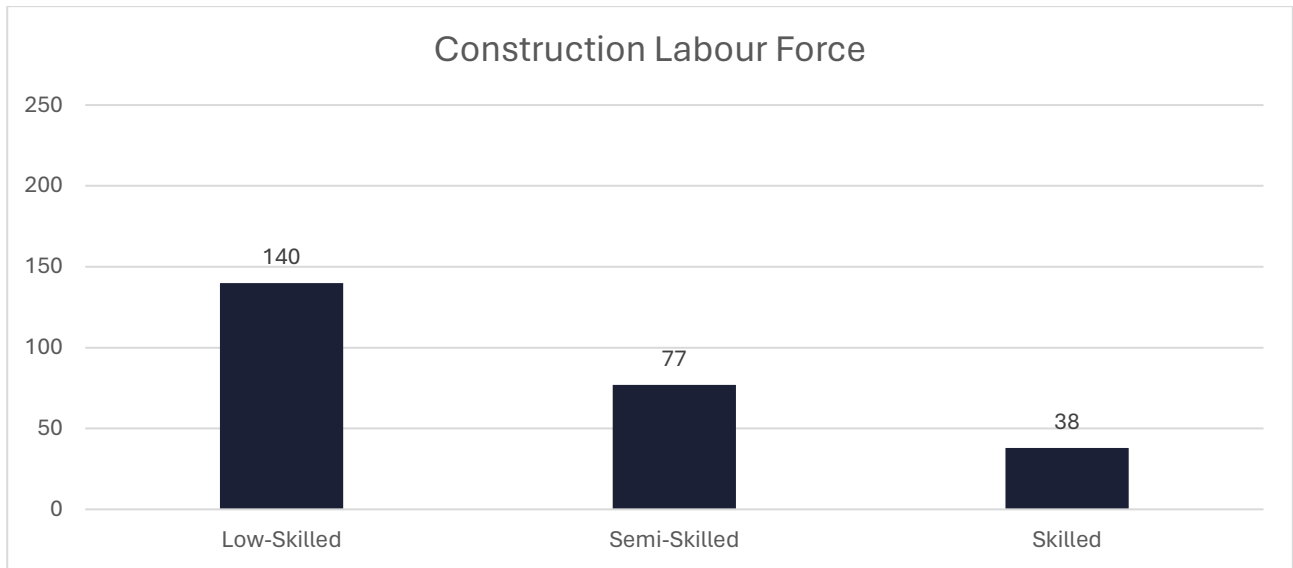

Figure 6-6: Construction Labour Force Breakdown

### 6.1.1.3 Summary of All Construction Traffic

Based on the above, it was assumed that the skilled labour force will drive to site using cars while a portion (35%) of the semi-skilled group will drive cars and the remaining portion (65%) will use buses to site. The low skilled component of the labour force is expected to be transported to site by bus. The above means that 25% (skilled 100% + 30% semi-skilled) is anticipated to use cars to site and 75% (100% low-skilled + 65% semi-skilled) to be bussed to site. The number of vehicles using a vehicle occupancy factor of 1.2 and 60 for car and bus respectively is expected to be 54 cars and 4 buses during construction. For the purposes of this report, it was assumed that these vehicles will travel during the AM and PM Peak hours and were applied as such during the analysis. A summary of all construction related trip generation trips is shown in Table 6-2.

Table 6-2: Construction Period Trip Generation

Activity	Period (days)	Components	Loads /Turbine	Total 1-way Trips	Daily Trips	Peak Hours Trips	PCU/ day
Transportation of WT Components	180	Blade (abnormal)	3	87	1	1	4
		Tower (abnormal)	3	87	1	1	4
		Hub (abnormal)	1	29	1	1	4
		Nacelle (abnormal)	1	29	1	1	4
		Reinforced Concrete works	157	4553	25	13	38
		Road Layer works	90	2610	15	7	21
132 KV Line	180	Cabling and other Pylon Equipment	0	4	4	4	12
Site Work Activities	480	Construction Vehicles & Water Tanker	31	899	2	1	3
		Crane Transport	2	4	0	0	0



		Labour Transport (Passenger Vehicles)	54	54	108	54	54
		Labour Transport (Bus)	4	4	8	4	12
<b>Total</b>			<b>346</b>	<b>8360</b>	<b>166</b>	<b>87</b>	<b>156</b>

Table 6-2 shows that the total traffic anticipated for the construction phase of the development is a total 87 vehicles per hour. To evaluate capacity requirements, the vehicles were converted to PCU using a factor of 3 car equivalent units for buses and trucks. A car equivalent factor of 4 for abnormal trucks was used. The total number of 156 PCU per day was used as true reflection of the anticipated construction traffic for the development.

### 6.1.2 Operational Phase Traffic

The operational phase is expected to have comparatively minimal traffic impact as the only transport required will be associated with monitoring, operation, and maintenance. For the operational phase of the wind farm, the following assumptions were made:

- The wind farm will be in operation over a 20-year lifespan.
- Activities on the wind farm include maintenance on an ongoing basis.
- Approximately 29 permanent staff will be working on the site consisting of operational and maintenance technicians, rehabilitation of vegetation, bird and bat post construction monitoring. The labour force will be made up of approximately 15% of skilled, 30% semi-skilled and 55% low skilled. This essentially means 16 of the staff will be low-skilled, 9 semi-skilled and 4 will be fully skilled.
- Skilled staff will likely make use of passenger vehicles and light duty trucks (i.e., Bakkie/4x4) to commute to site daily. Low-skilled and semi-skilled staff are expected to be transported to site by minibus taxis or by bus.
- There will be a possibility for excavations, planned and emergency maintenance, replacement or service of a WT components requiring the use of the above mentioned heavy and abnormal vehicles travelling from nearby areas.
- It is assumed during a maintenance/service or repair event, at least 3 trucks will be expected on site: 1 abnormal vehicle and 2 Heavy vehicles (equipment trucks).

A summary of all operational related trip generation trips is shown in Table 6-3.

Table 6-3: Operation Phase Trip Generation

Activity	Period (Years)	Components	Loads/ Turbine	Total 1 way Trips	Daily	Peak Hours Trips	PCU/ day
<b>1 Repair Event</b>	20	Abnormal Truck	1	1	2	1	4
		Trucks	2	2	4	2	6
<b>Daily Operation Activities</b>	20	Labour Transport (Passenger Vehicles)		6	12	6	6
		Minibus		2	4	2	2
<b>Total</b>			<b>3</b>	<b>11</b>	<b>22</b>	<b>11</b>	<b>18</b>

The operational phase of the development is expected to generate approximately 11 vehicles per hour. About 3 of these vehicles are heavy vehicles including an abnormal vehicle. Using a car equivalent factor of 4 for abnormal and 3 for normal trucks, the development will generate approximately 18 Passenger Car Units during the peak hours and were used as such during the analysis.

### 6.1.3 Decommissioning Phase Traffic

There are three possibilities for the decommissioning phase of the project as listed below.

1. After the 20-year lifespan of the Wind Energy Facility, the need for continued generation of electricity through wind energy is still required and the facility is renovated with new towers on the existing foundation in order to serve another 20 years.
2. The Wind Energy Facility is converted into another alternative renewable energy facility. The specifications around this are unknown.
3. There is no longer an economical / technical basis for an energy plant and the Wind Energy Facility is decommissioned and the land is rehabilitated.

For trip generation purposes, the third possibility was considered as a conservative assumption. Therefore, the relevant assumption made in the construction phase was used here as it will take about 2 years to decommission and rehabilitate the site. About 255 people will be needed with similar transport in the construction phase. All parts will be either reused or recycled and would most likely make their way back to the applicable Port. The decommissioning phase is expected to generate the second highest traffic impact after construction as a result of the need to remove the infrastructure and rehabilitate the site. A summary of all decommissioning trips generated is presented in Table 6-4.

Table 6-4: Decommissioning Trips Generated

Activity	Period (days)	Components	Loads /Turbine	Total way Trips <sup>1</sup>	Daily	Peak Hours Trips	PCU/day
Recycling of WT Components	180	Blade (abnormal)	8	272	4	4	16
Rubble removal and flattening	480	Construction Vehicles & Water Tanker	63	1827	4	2	6
Labour Transport		Labour Transport (Passenger Vehicles)	54	54	108	54	54
		Labour Transport (Bus)	4	4	8	4	12
<b>Total</b>			<b>129</b>	<b>2157</b>	<b>124</b>	<b>64</b>	<b>88</b>

The decommissioning phase of the development is expected to generate approximately 64 vehicles per hour. About 4 of these vehicles are abnormal vehicles. Using a car equivalent factor of 4 for abnormal and 3 for normal trucks, the development will generate approximately 88 Passenger Car Units during the peak hours and were used as such during the analysis.

## 6.2 Trip Distribution

The trip distribution and assignment of the development trips is shown in Figure J2 to Figure J8 in Appendix J – Traffic Flow Diagrams.

## 6.3 Traffic Analysis Results

### 6.3.1 Background

It is required to grow background traffic flow to an acceptable horizon year to ensure that the future road network would be able to operate adequately. In the absence of historical data, the COTO, TMH17 Volume 1 Manual provides typical growth rates to be used for growth areas based on the existing/anticipated rate of growth. Typical traffic growth rates are illustrated in Table 6-5.

Table 6-5: Typical Traffic Growth Rates

Development Area	Growth Rate
Low Growth Areas	0% - 3%
Average Growth Areas	3% - 4%
Above Average Growth Areas	4% - 6%
Fast Growing Areas	6% - 8%
Exceptionally High Growth Areas	> 8%

The site area was considered to be a low growth area. Taking into account the additional WEF being developed in the area, a 3% per annum growth rate was assumed to represent the expected traffic growth for the short to medium term (2024 to 2029). A low 1% per annum was used to forecast the traffic long term (2029 to 2046) in order to investigate capacity requirements for the decommissioning phase. This is due to unknowns on the long term prospects of the area. Further to this, it is not advisable to project over 20 years without detailed land use information informed by the SDF and the SDP of the wider area. It is therefore proposed that a detailed traffic impact study for the decommissioning phase be undertaken prior to the decommissioning stage commencing. To identify any shortcomings in the road-based capacity, the following scenarios were analysed:

1. Existing 2024 AM and PM Peak hour Traffic;
2. Existing 2024 + Construction Phase AM and PM Peak hour Traffic;
3. Background 2029 + Operation Phase AM and PM Peak hour Traffic; and
4. Horizon 2046 + Decommissioning Phase AM and PM Peak hour Traffic.

### 6.3.2 Intersection Capacity Operation Analysis

The operational performance of an intersection is defined by the level of service (LOS) for each approach to the intersection. These definitions, as defined in the Highway Capacity Manual (HCM) (Reference 5), relate average delays at intersections for individual turning movements, for each approach and for the overall intersection to a Level of Service (LoS) ranging from A to F, as shown in Table 6-6.

Table 6-6: Intersection Capacity Based Level of Service Criteria

Level of Service	Control Delay per Vehicle in Seconds (d)	
	Signals and Roundabouts	Stop Signs and Yield Signs
A	$d \leq 10$	$d \leq 10$
B	$10 < d \leq 20$	$10 < d \leq 15$
C	$20 < d \leq 35$	$15 < d \leq 25$
D	$35 < d \leq 55$	$25 < d \leq 35$
E	$55 < d \leq 80$	$35 < d \leq 50$
F	$80 < d$	$50 < d$

During the peak hours, the road infrastructure capacity provided should ensure that the intersection approach level of service should ideally not exceed LOS D. Because the site is located in a rural part of the country, the acceptable LOS for Rural class 1-2 roads is LOS B on normal days and LOS C on abnormal days.

It should be noted that overall Intersection LOS and Major Road Approach LOS values are not applicable for two-way priority/stop control since the average delay is not a good LOS measure due to zero delays associated with



major road movements, however, results will give an indication of delay and LOS for the minor road approaching the major road.

Intersection capacity analysis results for all scenarios are outlined in the following subsections.

**6.3.2.1 Scenario 1: Existing 2024 AM and PM Peak hour Traffic**

The traffic volumes representing this scenario are included in Figure J1, Appendix J. All intersections are currently operating at acceptable level of service (LOS A). Capacity analysis results for this scenario are summarised in Table 6-7.

Table 6-7: 2024 Existing AM and PM Peak Hour Results

Intersection		AM Peak Hour				PM Peak Hour			
Name	Approach	Demand (veh/h)	V/C (ratio)	Delay (sec)	LOS	Demand (veh/h)	V/C (ratio)	Delay (sec)	LOS
Intersection 1: R318 and N1	South	7	0.011	10.1	B	3	0.005	10.6	B
	East	93	0.058	0.3	A	254	0.137	0.1	A
	North	3	0.004	7.2	A	3	0.004	7.4	A
	West	222	0.086	0.2	A	136	0.0068	0.3	A
	<b>Overall</b>	<b>325</b>	<b>0.086</b>	<b>0.5</b>	<b>A</b>	<b>396</b>	<b>0.137</b>	<b>0.3</b>	<b>A</b>
Intersection 2: R318 and DR01442 (Access to Matroosbergstasie)	South	6	0.003	0.9	A	2	0.001	2.8	A
	North	5	0.003	1.1	A	7	0.004	0.8	A
	West	5	0.003	5.5	A	2	0.001	5.5	A
	<b>Overall</b>	<b>17</b>	<b>0.003</b>	<b>2.4</b>	<b>A</b>	<b>12</b>	<b>0.004</b>	<b>2</b>	<b>A</b>
Intersection 3: R318 and OP05749 (Nadini Access road)	South	5	0.003	1.1	A	4	0.002	1.4	A
	East	2	0.001	5.5	A	2	0.001	5.5	A
	North	4	0.002	1.4	A	7	0.004	0.8	A
	<b>Overall</b>	<b>12</b>	<b>0.003</b>	<b>2</b>	<b>A</b>	<b>14</b>	<b>0.004</b>	<b>1.7</b>	<b>A</b>
Intersection 4: R318 and OP05748 access road to Middelberg	South	5	0.003	1.1	A	4	0.003	1.4	A
	North	5	0.003	1.1	A	7	0.004	0.8	A
	West	2	0.001	5.5	A	2	0.001	5.5	A
	<b>Overall</b>	<b>13</b>	<b>0.003</b>	<b>1.8</b>	<b>A</b>	<b>14</b>	<b>0.004</b>	<b>1.7</b>	<b>A</b>
Intersection 5: R318 and DR01428 (Nougaspoort Access road)	South	6	0.004	1.8	A	3	0.002	1.8	A
	East	2	0.002	7.8	A	2	0.002	7.8	A
	North	6	0.004	2.8	A	7	0.004	0.8	A
	<b>Overall</b>	<b>14</b>	<b>0.004</b>	<b>0.1</b>	<b>A</b>	<b>12</b>	<b>0.05</b>	<b>0.1</b>	<b>A</b>
Intersection 6: R318 and OP05962 access road to Keerom O/G Pad	South	6	0.005	0.7	A	3	0.002	1.8	A
	North	7	0.004	0.8	A	8	0.005	0.7	A
	West	2	0.002	7.8	A	2	0.002	7.8	A
	<b>Overall</b>	<b>187</b>	<b>0.05</b>	<b>1.6</b>	<b>A</b>	<b>13</b>	<b>0.005</b>	<b>2.0</b>	<b>A</b>

6.3.2.2 Scenario 2: Existing 2024 + Construction Phase AM and PM Peak hour Traffic

The traffic volumes representing this scenario are included in Figure J6, Appendix J. All intersections are currently operating at acceptable level of service (LOS A). Capacity analysis results for this scenario are summarised in Table 6-8.

Table 6-8: 2024 Existing + Construction Phase AM and PM Peak Hour Results

Intersection		AM Peak Hour				PM Peak Hour			
Name	Approach	Demand (veh/h)	V/C (ratio)	Delay (sec)	LOS	Demand (veh/h)	V/C (ratio)	Delay (sec)	LOS
Intersection 1: R318 and N1	South	70	0.099	10.2	B	67	0.091	10.0	B
	East	120	0.076	1.7	A	173	0.104	1.2	A
	North	3	0.004	10.4	B	3	0.004	10.1	B
	West	259	0.108	1.3	A	177	0.078	2.0	A
	<b>Overall</b>	<b>452</b>	<b>0.108</b>	<b>2.9</b>	<b>A</b>	<b>420</b>	<b>0.104</b>	<b>3.0</b>	<b>A</b>
Intersection 2: R318 and DR01442 (Access to Matroosbergstasie)	South	71	0.045	0.1	A	67	0.043	0.1	A
	North	88	0.058	0.1	A	88	0.058	0.1	A
	West	5	0.004	5.8	A	2	0.002	5.9	A
	<b>Overall</b>	<b>164</b>	<b>0.058</b>	<b>0.3</b>	<b>A</b>	<b>157</b>	<b>0.058</b>	<b>0.2</b>	<b>A</b>
Intersection 3: R318 and OP05749 (Nadini Access road)	South	70	0.044	0.1	A	69	0.044	0.1	A
	East	2	0.002	5.9	A	2	0.002	5.9	A
	North	85	0.056	0.1	A	88	0.058	0.1	A
	<b>Overall</b>	<b>157</b>	<b>0.056</b>	<b>0.2</b>	<b>A</b>	<b>159</b>	<b>0.058</b>	<b>0.2</b>	<b>A</b>
Intersection 4: R318 and OP05748 access road to Middelberg	South	70	0.038	0.1	A	69	0.037	0.1	A
	North	86	0.047	0.1	A	88	0.048	0.1	A
	West	2	0.002	5.8	A	2	0.002	5.8	A
	<b>Overall</b>	<b>158</b>	<b>0.047</b>	<b>0.2</b>	<b>A</b>	<b>159</b>	<b>0.048</b>	<b>0.1</b>	<b>A</b>
Intersection 5: R318 and DR01428 (Nougaspoort Access road)	South	13	0.008	4.0	A	9	0.006	4.5	A
	East	73	0.061	5.6	A	72	0.060	5.6	A
	North	87	0.050	5.4	A	187	0.049	5.2	A
	<b>Overall</b>	<b>173</b>	<b>0.061</b>	<b>5.4</b>	<b>A</b>	<b>168</b>	<b>0.060</b>	<b>5.3</b>	<b>A</b>
Intersection 6: R318 and OP05962 access road to Keerom O/G Pad	South	15	0.009	0.4	A	10	0.007	0.6	A
	North	14	0.009	0.4	A	14	0.009	0.4	A
	West	2	0.001	5.6	A	2	0.001	5.5	A
	<b>Overall</b>	<b>31</b>	<b>0.009</b>	<b>0.7</b>	<b>A</b>	<b>26</b>	<b>0.009</b>	<b>0.9</b>	<b>A</b>

6.3.2.3 Scenario 3: Existing 2029 + Operation Phase AM and PM Peak hour Traffic

The traffic volumes representing this scenario are included in Figure J7, Appendix J. All intersections are currently operating at acceptable level of service (LOS A). Capacity analysis results for this scenario are summarised in Table 6-9.

Table 6-9: 2029 Background + Construction Phase AM and PM Peak Hour Results

Intersection		AM Peak Hour				PM Peak Hour			
Name	Approach	Demand (veh/h)	V/C (ratio)	Delay (sec)	LOS	Demand (veh/h)	V/C (ratio)	Delay (sec)	LOS
Intersection 1: R318 and N1	South	14	0.022	10.4	B	12	0.018	11.0	B
	East	105	0.069	0.4	A	279	0.162	0.1	A
	North	3	0.005	11.8	B	3	0.005	12.4	B
	West	248	0.102	0.3	A	153	0.066	0.5	A
	<b>Overall</b>	<b>370</b>	<b>0.102</b>	<b>0.8</b>	<b>A</b>	<b>446</b>	<b>0.162</b>	<b>0.6</b>	<b>A</b>
Intersection 2: R318 and DR01442 (Access to Matroosbergstasie)	South	14	0.009	0.4	A	9	0.006	0.6	A
	North	16	0.010	0.4	A	15	0.010	0.4	A
	West	6	0.004	5.6	A	2	0.001	5.5	A
	<b>Overall</b>	<b>35</b>	<b>0.010</b>	<b>1.3</b>	<b>A</b>	<b>26</b>	<b>0.010</b>	<b>0.9</b>	<b>A</b>
Intersection 3: R318 and OP05749 (Nadini Access road)	South	13	0.008	0.4	A	12	0.008	0.5	A
	East	2	0.001	5.5	A	2	0.001	5.6	A
	North	12	0.007	0.5	A	15	0.008	0.4	A
	<b>Overall</b>	<b>27</b>	<b>0.008</b>	<b>0.8</b>	<b>A</b>	<b>31</b>	<b>0.008</b>	<b>0.8</b>	<b>A</b>
Intersection 4: R318 and OP05748 access road to Middelberg	South	13	0.007	0.4	A	12	0.007	0.5	A
	North	13	0.007	0.4	A	15	0.008	0.4	A
	West	2	0.001	5.5	A	2	0.001	5.5	A
	<b>Overall</b>	<b>28</b>	<b>0.007</b>	<b>0.8</b>	<b>A</b>	<b>29</b>	<b>0.008</b>	<b>0.8</b>	<b>A</b>
Intersection 5: R318 and DR01428 (Nougaspoot Access road)	South	9	0.005	2.4	A	4	0.003	2.8	A
	East	10	0.008	5.5	A	9	0.007	5.5	A
	North	14	0.008	4.4	A	14	0.008	2.8	A
	<b>Overall</b>	<b>33</b>	<b>0.008</b>	<b>4.2</b>	<b>A</b>	<b>27</b>	<b>0.008</b>	<b>3.7</b>	<b>A</b>
Intersection 6: R318 and OP05962 access road to Keerom O/G Pad	South	11	0.007	0.5	A	5	0.004	1.1	A
	North	10	0.006	0.6	A	10	0.006	0.5	A
	West	2	0.001	5.5	A	2	0.001	5.5	A
	<b>Overall</b>	<b>23</b>	<b>0.007</b>	<b>1.0</b>	<b>A</b>	<b>18</b>	<b>0.006</b>	<b>1.3</b>	<b>A</b>



6.3.2.4 Scenario 4: Horizon 2046 + Decommission Phase AM and PM Peak hour Traffic

The traffic volumes representing this scenario are included in Figure J8, Appendix J. All intersections are currently operating at acceptable level of service (LOS A). Capacity analysis results for this scenario are summarised in Table 8-10.

Table 6-10: 2046 Background + Decommission Phase AM and PM Peak Hour Results

Intersection		AM Peak Hour				PM Peak Hour			
Name	Approach	Demand (veh/h)	V/C (ratio)	Delay (sec)	LOS	Demand (veh/h)	V/C (ratio)	Delay (sec)	LOS
Intersection 1: R318 and N1	South	38	0.065	11.2	B	33	0.063	12.3	B
	East	135	0.087	0.9	A	330	0.192	0.1	A
	North	3	0.006	12.3	B	3	0.006	13.8	B
	West	320	0.133	0.8	A	208	0.094	1.5	A
	<b>Overall</b>	<b>496</b>	<b>0.133</b>	<b>1.7</b>	<b>A</b>	<b>574</b>	<b>0.192</b>	<b>1.4</b>	<b>A</b>
Intersection 2: R318 and DR01442 (Access to Matroosbergstasie)	South	37	0.025	0.2	A	32	0.023	0.2	A
	North	55	0.039	0.1	A	55	0.039	0.1	A
	West	6	0.004	5.7	A	2	0.002	5.7	A
	<b>Overall</b>	<b>98</b>	<b>0.039</b>	<b>0.5</b>	<b>A</b>	<b>89</b>	<b>0.039</b>	<b>0.3</b>	<b>A</b>
Intersection 3: R318 and OP05749 (Nadini Access road)	South	36	0.025	0.0	A	35	0.024	0.2	A
	East	2	0.002	5.7	A	2	0.002	5.8	A
	North	51	0.036	0.1	A	55	0.038	0.1	A
	<b>Overall</b>	<b>89</b>	<b>0.036</b>	<b>0.3</b>	<b>A</b>	<b>92</b>	<b>0.038</b>	<b>0.3</b>	<b>A</b>
Intersection 4: R318 and OP05748 access road to Middelberg	South	36	0.020	0.2	A	35	0.019	0.2	A
	North	52	0.028	0.1	A	55	0.030	0.1	A
	West	2	0.002	5.7	A	2	0.002	5.7	A
	<b>Overall</b>	<b>90</b>	<b>0.028</b>	<b>0.3</b>	<b>A</b>	<b>92</b>	<b>0.030</b>	<b>0.2</b>	<b>A</b>
Intersection 5: R318 and DR01428 (Nougaspoort Access road)	South	14	0.008	3.6	A	10	0.006	4.0	A
	East	38	0.031	5.6	A	2	0.001	5.6	A
	North	54	0.031	5.1	A	53	0.030	4.7	A
	<b>Overall</b>	<b>106</b>	<b>0.031</b>	<b>5.1</b>	<b>A</b>	<b>65</b>	<b>0.030</b>	<b>4.6</b>	<b>A</b>
Intersection 6: R318 and OP05962 access road to Keerom O/G Pad	South	17	0.011	0.3	A	10	0.007	0.6	A
	North	16	0.010	0.3	A	16	0.010	0.3	A
	West	2	0.001	5.6	A	2	0.001	5.6	A
	<b>Overall</b>	<b>35</b>	<b>0.011</b>	<b>0.6</b>	<b>A</b>	<b>28</b>	<b>0.010</b>	<b>0.8</b>	<b>A</b>

## 7 Transport Management Plan

The section discusses traffic management techniques, vehicle requirements, and stakeholder collaboration for the construction and operation of wind energy facilities. Temporary signage, speed limits, road closures, diversions, and traffic signals are all addressed. Road authorities, municipalities, police, emergency services, communities, landowners, contractors, and suppliers are among the key stakeholders to be engaged.

### 7.1 Abnormal Weights and Dimension

#### 7.1.1 Evaluation of Abnormal Weights and Dimensions

Transport requirements for the Wind Energy Facility project will require the use of abnormal load vehicles as stipulated in TRH 11, especially in the construction phase of the project for the delivery of construction materials and turbine components. Very little to no special transport will be required during the remainder of the development phases, as conventional transport will be used.

All wind turbine components are considered to be abnormal loads, either through length, weight, or height, usually comprising of 3 tower sections, 1 hub, 1 nacelle, and 3 blades. These require different truck and trailer combinations and configurations to be transported. These issues will be investigated at a later stage when the transporting contractor and the plant hire companies apply for the necessary permits from the permit-issuing authorities. The heaviest component of a wind turbine is the nacelle (approximately 67 to 85 tons, depending on the manufacturer and design of the unit). Combined with road-based transport, it has a total vehicle mass of approximately 130 000 kg (for the 85-ton unit). Route clearances and permits will be required for transporting the nacelle by road-based transport.

Blades are the longest component at 100 m and need to be transported on a specially imported extendible blade transport trailer or in a rigid container with rear steerable dollies. The blades can be transported individually, in pairs, or in threes, although different manufacturers have different methods of packaging and transporting the blades. Where required, existing public roads may need to be upgraded along the proposed equipment transport route to allow for the transportation and delivery of wind turbine components and other associated infrastructure components. The national roads on the potential national access routes are generally of high standard, and many of the structures have been assessed for load-bearing capacity and height clearance in the past. The turbine supplier or contractors selected for implementation would be responsible for the transportation of wind turbine components to the site. A complete transportation management plan should be undertaken prior to construction, should the project be awarded preferred bidder status.

#### 7.1.2 Permit Requirements

In the transportation of loads, the following guidelines are available: According to TRH 11, the expected load dimensions are classified as abnormal loads; therefore, an exemption permit for each province where the load has to transit is required. Provision for the type of abnormal loads in this development is made in the National Road Transport Act (NRTA), and specifically in Section 81 of the NRTA, which reads as follows:

***“Vehicle and load may be exempted from provisions of Act***

*An MEC may, subject to such conditions as upon payment of such fees or charges as he or she may determine, authorise in writing, either generally or specifically, the operation on a public road of a vehicle which does not comply with the provisions of this Act or the conveyance on a public road of passengers or any load otherwise that in accordance with the provisions of this Act.”*

When the movement of an abnormal load is considered to be in the country's economic and/or social interest, an exemption permit may be provided to allow a vehicle(s) conveying such an abnormal load to operate on a public road for a limited time. The essential principles that will guide this procedure are as follows:

- An exemption permit for an abnormal load will only be considered for an indivisible load, abnormal in dimension and/or mass, where there is no possibility of transporting the load in a legal manner;

- The risks to other users must be reduced to a level equivalent to what it would be without the presence of the abnormal vehicle on the road; and
- The conditions imposed must take the economic and/or social interest of the country and public at large into account.

### 7.1.3 Types of Abnormalities

The Wind Energy Facility is anticipated to carry loads that are considered to be indivisible and can be abnormal either dimensionally, abnormal in mass, or abnormal both dimensionally and in mass. The following is the legally permissible maximum dimension or mass.

**Length:** Truck and Semi-Trailer (Tri-Axle) Overall length of combination (including load projections) - 18.50 m  
 Superlink (6 m + 12 m trailers) Overall length of combination (no load projections)- 22.00 m.

**Width:** 2.60 m

**Height:** 4.30 m measured from the ground. The height of a conventional trailer is 1.60 m from the ground to the trailer deck; therefore, the permissible height of the load is 2.70 m.

**Weight:** 13.50 m Tri-Axle 28 Ton/15.00 m Tri-Axle 30 Ton Superlink 34 Ton Gross (6.00 m–10/12 Ton & 12 m–24/22 Ton)

The Wind Energy Facility components are classified as abnormal loads and will necessitate an application to the Department of Transport and Public Works for a permit authorizing the conveyance of said load. With the required permits in place, the following escort vehicles (whether they are the client's own escort vehicles or provincial traffic officers) will be necessary to escort the transportation of abnormal loads. The anticipated escort vehicles are presented in Table 7-1.

It must be noted Loads with a height of 4.70 m measured from the ground require –1 x Own Escort vehicle. For loads of 5.50 m + high Telkom & Eskom Clearances are required for the lifting of overhead lines. Upon final selection of wind turbine models to be used, the exact amount of escort vehicles can be determined.

Table 7-1: Escort Vehicles

Component	Details	Escort Vehicles
<b>Tower</b>	Length: 150 m	3 Tower sections/WT 2 x Provincial Traffic Escorts (subject to width of load)
<b>Rotor</b>	Blade Length: 100 m Hub	Blades/WT Connected to 1 Hub/WT 2 x Provincial Traffic Escorts (subject to width of load)

## 7.2 Impact on Road Users

There is potential for the transportation of components and construction materials to have an impact on the general traffic and local community. The presence of the heavy vehicles required during the construction and decommissioning phase may also cause noise and dust impacts which impact local residence located close to the Wind Energy Facility site. These impacts may be minimised by:



- Scheduling abnormal and heavy vehicle transport by proper distribution of arrivals and departure to avoid high numbers of vehicles arriving at once;
- Additional traffic management control measures at site accesses to limit impact, i.e., signage; and
- Traffic accommodation during any upgrades on access points, i.e., Stop-go system. An example of a Stop-go operation is presented in Figure 7-1.

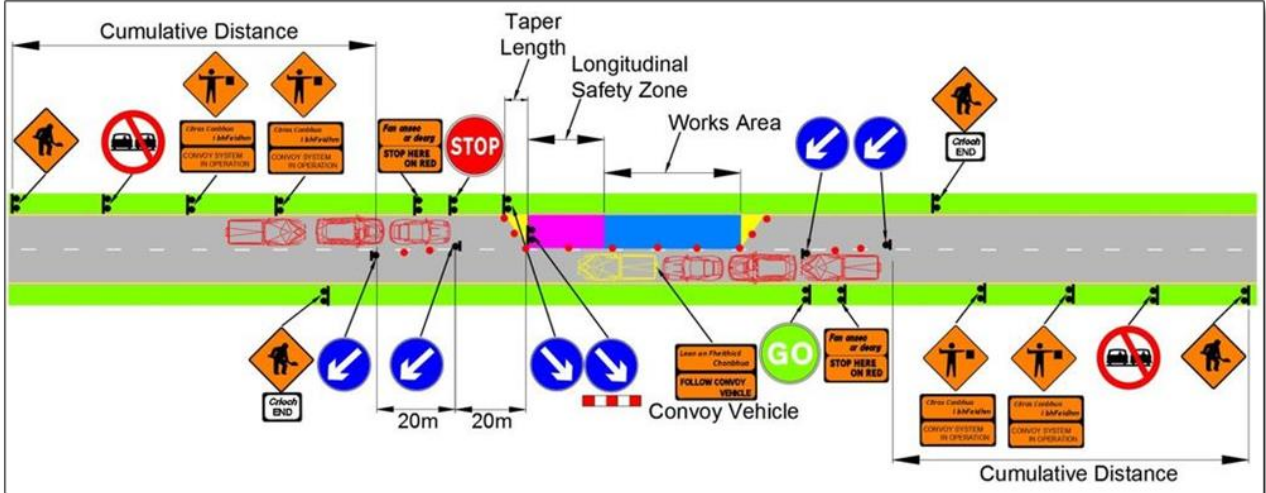

Figure 7-1: Stop-Go Operation (Source: Temporary Traffic Management Design Guidance)

## 8 Traffic Impact Ratings

### 8.1 Methodology

This section describes the impact assessment methodology used to assess the anticipated traffic and transportation related impacts. The impact assessment methodology which was used in this assessment was developed by ERM – Environmental Resources Management and involves a 7-step approach for determining the significance of potential impacts in accordance with the requirements of Appendix 3 of the EIA Regulations, 2014 (as amended).

The overall approach in calculating the impact score starts with the identification and prediction of an impact whereby impact criteria such as the extent (E), duration (D), magnitude (M), reversibility (R), probability (P) of the identified impact (nature (N)), are rated from a scale of 1 to 5 based on degree of occurrence and factored to calculate the significance (S) of each impact. Detailed description of the rating (1-5) definition and impact criteria are provided in Appendix K – Impact Assessment Methodology. The associated significance (S) score of the impact is then determined by the following mathematical relationship:

- $S = (E+D+M+R) * P.$

Furthermore, other factors, including cumulative impacts and potential for irreplaceable loss of resources are considered. The overall signification (S) ranging from 1 through to 100 is categorised as follows:

- 0 – 30: Low (i.e., where this impact is unlikely to be a significant environmental risk);
- 31 - 60: Moderate (i.e., where the impact could have a significant environmental risk); and
- 61 - 100: High (i.e., where the impact will have a significant environmental risk resulting in substantial deterioration or exceeding recommended levels).

The significance of environmental impact is calculated for each impact prior and post mitigation measures to assess the effectiveness of impact management plans. In addition, the assessment is undertaken for each development phase i.e., construction, operation, and decommissioning.

Table 8-1 provides a high-level summary of the impact criteria and assessment methodology.

Table 8-1: ERM Impact Assessment Methodology

Impact Criteria	Significance	Final Score																							
Extent (E)	Significance = (E+D+M+R) * P	<table border="1"> <thead> <tr> <th colspan="3">Significance is deemed Negative (-)</th> <th colspan="3">Significance is deemed Positive (+)</th> </tr> <tr> <th>0 - 30</th> <th>31 - 60</th> <th>61 - 100</th> <th>0 - 30</th> <th>31 - 60</th> <th>61 - 100</th> </tr> </thead> <tbody> <tr> <td>Low</td> <td>Moderate</td> <td>High</td> <td>Low</td> <td>Moderate</td> <td>High</td> </tr> </tbody> </table>						Significance is deemed Negative (-)			Significance is deemed Positive (+)			0 - 30	31 - 60	61 - 100	0 - 30	31 - 60	61 - 100	Low	Moderate	High	Low	Moderate	High
Significance is deemed Negative (-)								Significance is deemed Positive (+)																	
0 - 30								31 - 60	61 - 100	0 - 30	31 - 60	61 - 100													
Low								Moderate	High	Low	Moderate	High													
Duration (D)																									
Magnitude (M)																									
Reversibility (R)																									
Probability (P)																									
Status (S)	Negative (-) or Positive (+) or Neutral																								
Nature (N)	Name of Impact																								

### 8.2 Assumptions and Limitations

The assessment has been prepared based on the information provided by the Client and the following assumptions, amongst others:

- It was assumed that the construction period will last approximately 2 years with a 5-day working week resulting in 480 working days over 24 months.
- Construction trips were estimated without a detailed construction schedule programme.

- For the assessment of cumulative impacts, a conservative approach was adopted by assuming that all wind energy facilities within 30 km currently approved, planned or proposed would be constructed concurrently.
- WTG components will be imported and transported with abnormal vehicles from the most feasible port of entry/harbour.
- Haulage will occur on surfaced national and provincial roads and existing site access gravel roads.
- Construction material and labour force will be sourced locally.

## 8.3 Assumptions and Limitations

### 8.3.1 Impact Significance for Construction Phase

The construction phase is expected to generate the highest number of vehicles over the construction period of approximately 2 years. Table 8-2 to Table 8-5 indicate the identified nature of impact and impact significance associated with the construction phase.

Table 8-2: Impact Summary Table for Construction Phase – Increased General Traffic

<b>Impact Phase:</b> Construction					
<b>Nature of the impact:</b> Increase in general peak hour traffic volumes					
<b>Description of Impact:</b> Increased traffic on the route and access points to site - Potential to be greater than what the existing road capacity of the local road network can handle in order to operate at an acceptable level of service.					
This impact relates to potential disruption of traffic on local, regional and national roads. The severity of the impacts will depend on the order of the road (how many lanes, lanes width, length, turns, etc.), the receiving environment and vicinity of land uses and towns.					
Additional traffic on the road network could result in changes to the operations of that road network, intersection capacity, such as increased congestion, delays, and accidents.					
<b>Impact Status:</b> Negative					
	<b>E</b>	<b>D</b>	<b>R</b>	<b>M</b>	<b>P</b>
<b>Without Mitigation</b>	Regional	Short Term	Recoverable	Low	Probable
<b>Score</b>	3	2	3	2	3
<b>With Mitigation</b>	Local	Short Term	Reversible	Very Low	Probable
<b>Score</b>	2	2	1	1	3
<b>Significance Calculation</b>	<b>Without Mitigation</b>		<b>With Mitigation</b>		
<b>S=(E+D+R+M)*P</b>	Low Negative Impact (30)		Low Negative Impact (18)		
Was public comment received?	YES/ <b>NO</b> . If yes, provide a bullet summary of main concerns.				
Has public comment been included in mitigation measures?	YES/ <b>NO</b> , if NO then WHY? If YES then HOW/WHERE				
Mitigation measures to reduce residual risk or enhance opportunities: <i>Implementation of the Traffic Management Plan and Road Safety Measures</i> <i>Limit use of private cars</i> <i>Schedule development traffic movements to not coincide with existing peaks where possible</i> <i>Encourage use of public/staff transportation</i>					
Residual impact	Negative, moderate and temporary				

Table 8-3: Impact Summary Table for Construction Phase – Abnormal Heavy Traffic

<b>Impact Phase:</b> Construction					
<b>Nature of the impact:</b> Increase in abnormal traffic volumes					
<b>Description of Impact:</b> Additional heavy vehicles/E80's/Abnormal vehicles on the external road network- Potential to require additional road rehabilitation.					
The impact of abnormal loads on public roads is expected to cause journey time delays and traffic congestion due to low travelling speeds of heavy vehicles transporting abnormal loads. These often occupy two standard traffic lanes and can potentially lead to incidents when travelling on single carriageways with a single lane per direction and without traffic police escorts.					
<b>Impact Status:</b> Negative					
	<b>E</b>	<b>D</b>	<b>R</b>	<b>M</b>	<b>P</b>
<b>Without Mitigation</b>	National	Short Term	Recoverable	High	Probable
<b>Score</b>	4	2	3	4	3
<b>With Mitigation</b>	National	Short Term	Recoverable	Moderate	Probable
<b>Score</b>	4	2	3	3	3
<b>Significance Calculation</b>	<b>Without Mitigation</b>		<b>With Mitigation</b>		
<b>S=(E+D+R+M)*P</b>	Moderate Negative Impact (39)		Moderate Negative Impact (36)		
Was public comment received?	YES/NO. If yes, provide a bullet summary of main concerns.				
Has public comment been included in mitigation measures?	YES/NO, if NO then WHY? If YES then HOW/WHERE				
Mitigation measures to reduce residual risk or enhance opportunities: <i>Implementation of the Traffic Management Plan and Road Safety Measures</i> <i>Compliance to permissible heavy vehicle dimensions, permissible axle mass load on vehicles (no overloading)</i> <i>Transportation scheduling to consider the time of day when the abnormal loads would be moved</i> <i>Other alternative modes of transportation (rail where feasible) should be considered</i>					
Residual impact	Negative, moderate and temporary				



Table 8-4: Impact Summary Table for Construction Phase – Dust Generation

<b>Impact Phase:</b> Construction					
<b>Nature of the impact:</b> Impact of dust along gravel site access roads					
<b>Description of Impact:</b> Heavy vehicles are expected to cause dust along unpaved access roads to the site. This can affect the air quality and visibility for nearby residents and road users. Larger vehicles generate more dust which can limit the ability of other vehicles to overtake due to poor visibility.					
<b>Impact Status:</b> Negative					
	<b>E</b>	<b>D</b>	<b>R</b>	<b>M</b>	<b>P</b>
<b>Without Mitigation</b>	Site	Immediate	Recoverable	Moderate	Probable
<b>Score</b>	1	1	3	3	3
<b>With Mitigation</b>	Site	Immediate	Reversible	Low	Low Probability
<b>Score</b>	1	1	1	2	2
<b>Significance Calculation</b>	<b>Without Mitigation</b>		<b>With Mitigation</b>		
<b>S=(E+D+R+M)*P</b>	Low Negative Impact (24)		Low Negative Impact (14)		
Was public comment received?	YES/NO. If yes, provide a bullet summary of main concerns.				
Has public comment been included in mitigation measures?	YES/NO, if NO then WHY? If YES then HOW/WHERE				
Mitigation measures to reduce residual risk or enhance opportunities: <i>Dust control measures such as regular wet grading and wetting for dust suppression to minimize the negative impact</i>					
Residual impact	Yes, but acceptable.				

Table 8-5: Impact Summary Table for Construction Phase – Deterioration of Surrounding Road Network

<b>Impact Phase:</b> Construction					
<b>Nature of the impact:</b> Deterioration of surrounding road network					
<p><b>Description of Impact:</b> Heavy vehicle traffic during construction of the development is expected to cause additional wear and tear on the surrounding road network. Gravel access roads to the sites are also expected to sustain damage during the construction phase of the project.</p> <p>Abnormal loads can exert more pressure on road surfaces and infrastructure, leading to increased maintenance costs and reduced road network lifespan.</p>					
<b>Impact Status:</b> Negative					
	<b>E</b>	<b>D</b>	<b>R</b>	<b>M</b>	<b>P</b>
<b>Without Mitigation</b>	Local	Short Term	Recoverable	Moderate	Probable
<b>Score</b>	2	2	3	3	3
<b>With Mitigation</b>	Site	Immediate	Reversible	Low	Low Probability
<b>Score</b>	1	1	1	2	2
<b>Significance Calculation</b>	<b>Without Mitigation</b>		<b>With Mitigation</b>		
<b>S=(E+D+R+M)*P</b>	Low Negative Impact (30)		Low Negative Impact (10)		
Was public comment received?	YES/NO. If yes, provide a bullet summary of main concerns.				
Has public comment been included in mitigation measures?	YES/NO, if NO then WHY? If YES then HOW/WHERE				
<p>Mitigation measures to reduce residual risk or enhance opportunities:</p> <p><i>Limiting the number and frequency of heavy and overloaded vehicles where possible</i></p> <p><i>Undertaking regular maintenance, rehabilitation and upgrading substandard pavement conditions</i></p>					
Residual impact	Positive, roads will remain in better conditions post implementation of mitigation measures				

### 8.3.2 Impact Significance for Operation Phase

The operational phase of the development is expected to generate the least number of vehicles over the project lifespan of approximately 20 years.

Thus, the operational phase is expected to have comparatively minimal environmental impact as only the transport required will be associated with monitoring, operation, and maintenance.

Table 8-6 to Table 8-9 indicate the identified nature of impact and impact significance associated with the operational phase.

Table 8-6: Impact Summary Table for Operational Phase – Increased General Traffic

<b>Impact Phase:</b> Operation					
<b>Nature of the impact:</b> Increase in general peak hour traffic volumes					
<b>Description of Impact:</b> Increased traffic on the route and access points to site - Potential to be greater than what the existing road capacity of the local road network can handle in order to operate at an acceptable level of service.					
This impact relates to potential disruption of traffic on local, regional and national roads. The severity of the impacts will depend on the order of the road (how many lanes, lanes width, length, turns, etc.), the receiving environment and vicinity of land uses and towns.					
Additional traffic on the road network could result in changes to the operations of that road network, intersection capacity, such as increased congestion, delays, and accidents.					
<b>Impact Status:</b> Negative					
	<b>E</b>	<b>D</b>	<b>R</b>	<b>M</b>	<b>P</b>
<b>Without Mitigation</b>	Site	Immediate	Reversible	Very Low	Low Probability
<b>Score</b>	1	1	1	1	2
<b>With Mitigation</b>	Site	Immediate	Reversible	Very Low	Low Probability
<b>Score</b>	1	1	1	1	2
<b>Significance Calculation</b>	<b>Without Mitigation</b>		<b>With Mitigation</b>		
<b>S=(E+D+R+M)*P</b>	Low Negative Impact (8)		Low Negative Impact (8)		
Was public comment received?	YES/ <b>NO</b> . If yes, provide a bullet summary of main concerns.				
Has public comment been included in mitigation measures?	YES/ <b>NO</b> , if NO then WHY? If YES then HOW/WHERE				
Mitigation measures to reduce residual risk or enhance opportunities: <i>Implementation of the Traffic Management Plan and Road Safety Measures</i> <i>Limit use of private cars</i> <i>Schedule development traffic movements to not coincide with existing peaks where possible</i> <i>Encourage use of public/staff transportation</i>					
Residual impact	<i>Moderate and temporary</i>				

Table 8-7: Impact Summary Table for Operational Phase – Abnormal Heavy Traffic

<b>Impact Phase: Operation</b>					
<b>Nature of the impact:</b> Increase in abnormal traffic volumes					
<p><b>Description of Impact:</b> Additional heavy vehicles/E80's/Abnormal vehicles on the external road network- Potential to require additional road rehabilitation.</p> <p>The impact of abnormal loads on public roads is expected to cause journey time delays and traffic congestion due to low travelling speeds of heavy vehicles transporting abnormal loads. These often occupy two standard traffic lanes and can potentially lead to incidents when travelling on single carriageways with a single lane per direction and without traffic police escorts.</p>					
<b>Impact Status:</b> Negative					
	<b>E</b>	<b>D</b>	<b>R</b>	<b>M</b>	<b>P</b>
<b>Without Mitigation</b>	Regional	Immediate	Recoverable	Moderate	Probable
<b>Score</b>	3	1	3	3	3
<b>With Mitigation</b>	Regional	Immediate	Recoverable	Moderate	Low Probability
<b>Score</b>	3	1	3	3	2
<b>Significance Calculation</b>	<b>Without Mitigation</b>		<b>With Mitigation</b>		
<b>S=(E+D+R+M)*P</b>	Low Negative Impact (30)		Low Negative Impact (20)		
Was public comment received?	YES/NO. If yes, provide a bullet summary of main concerns.				
Has public comment been included in mitigation measures?	YES/NO, if NO then WHY? If YES then HOW/WHERE				
<p>Mitigation measures to reduce residual risk or enhance opportunities:</p> <p><i>Implementation of the Traffic Management Plan and Road Safety Measures</i></p> <p><i>Compliance to permissible heavy vehicle dimensions, permissible axle mass load on vehicles (no overloading)</i></p> <p><i>Transportation scheduling to consider the time of day when the abnormal loads would be moved</i></p> <p><i>Other alternative modes of transportation (rail where feasible) should be considered</i></p>					
Residual impact	Negative, moderate and temporary				



Table 8-8: Impact Summary Table for Operational Phase – Dust Generation

<b>Impact Phase: Operation</b>					
<b>Nature of the impact:</b> Impact of dust along gravel site access roads					
<b>Description of Impact:</b> Heavy vehicles are expected to cause dust along unpaved access roads to the site. This can affect the air quality and visibility for nearby residents and road users. Larger vehicles generate more dust which can limit the ability of other vehicles to overtake due to poor visibility.					
<b>Impact Status:</b> Negative					
	<b>E</b>	<b>D</b>	<b>R</b>	<b>M</b>	<b>P</b>
<b>Without Mitigation</b>	Site	Immediate	Recoverable	Low	Low Probability
<b>Score</b>	1	1	3	2	2
<b>With Mitigation</b>	Site	Immediate	Reversible	Very Low	Improbable
<b>Score</b>	1	1	1	1	1
<b>Significance Calculation</b>	<b>Without Mitigation</b>			<b>With Mitigation</b>	
<b>S=(E+D+R+M)*P</b>	Low Negative Impact (10)			Low Negative Impact (4)	
Was public comment received?	YES/ <b>NO</b> . If yes, provide a bullet summary of main concerns.				
Has public comment been included in mitigation measures?	YES/ <b>NO</b> , if NO then WHY? If YES then HOW/WHERE				
Mitigation measures to reduce residual risk or enhance opportunities: <i>Dust control measures such as regular wet grading and wetting for dust suppression to minimize the negative impact</i>					
Residual impact	<i>Negligible</i>				

Table 8-9: Impact Summary Table for Operational Phase – Deterioration of Surrounding Road Network

<b>Impact Phase:</b> Operation					
<b>Nature of the impact:</b> Deterioration of surrounding road network					
<p><b>Description of Impact:</b> Heavy vehicle traffic during construction of the development is expected to cause additional wear and tear on the surrounding road network. Gravel access roads to the sites are also expected to sustain damage during the construction phase of the project.</p> <p>Abnormal loads can exert more pressure on road surfaces and infrastructure, leading to increased maintenance costs and reduced road network lifespan.</p>					
<b>Impact Status:</b> Negative					
	<b>E</b>	<b>D</b>	<b>R</b>	<b>M</b>	<b>P</b>
<b>Without Mitigation</b>	Site	Immediate	Reversible	Low	Low Probability
<b>Score</b>	1	1	1	1	2
<b>With Mitigation</b>	Site	Immediate	Reversible	Low	Low Probability
<b>Score</b>	1	1	1	1	2
<b>Significance Calculation</b>	<b>Without Mitigation</b>			<b>With Mitigation</b>	
<b>S=(E+D+R+M)*P</b>	Low Negative Impact (8)			Low Negative Impact (8)	
Was public comment received?	YES/ <b>NO</b> . If yes, provide a bullet summary of main concerns.				
Has public comment been included in mitigation measures?	YES/ <b>NO</b> , if NO then WHY? If YES then HOW/WHERE				
<p>Mitigation measures to reduce residual risk or enhance opportunities:</p> <p><i>Limiting the number and frequency of heavy and overloaded vehicles where possible</i></p> <p><i>Undertaking regular maintenance, rehabilitation and upgrading substandard pavement conditions</i></p>					
Residual impact	<i>Positive, roads will remain in better conditions post implementation of mitigation measures</i>				

### 8.3.3 Impact Significance for Decommissioning Phase

It is expected that the decommissioning phase will have similar transport requirements in the construction phase. Thus, the decommissioning phases will generate the second highest traffic impact after construction as a result of the need to remove infrastructure and rehabilitate the site.

Table 8-10 to Table 8-13 indicate the identified nature of impact and impact significance associated with the decommission phase.

Table 8-10: Impact Summary Table for Decommission Phase – Increased General Traffic

<b>Impact Phase:</b> Decommission					
<b>Nature of the impact:</b> Increase in general peak hour traffic volumes					
<p><b>Description of Impact:</b> Increased traffic on the route and access points to site - Potential to be greater than what the existing road capacity of the local road network can handle in order to operate at an acceptable level of service.</p> <p>This impact relates to potential disruption of traffic on local, regional and national roads. The severity of the impacts will depend on the order of the road (how many lanes, lanes width, length, turns, etc.), the receiving environment and vicinity of land uses and towns.</p> <p>Additional traffic on the road network could result in changes to the operations of that road network, intersection capacity, such as increased congestion, delays, and accidents.</p>					
<b>Impact Status:</b> Negative					
	<b>E</b>	<b>D</b>	<b>R</b>	<b>M</b>	<b>P</b>
<b>Without Mitigation</b>	Regional	Short Term	Recoverable	Low	Probable
<b>Score</b>	3	2	3	2	3
<b>With Mitigation</b>	Local	Short Term	Reversible	Very Low	Probable
<b>Score</b>	2	2	1	1	3
<b>Significance Calculation</b>	<b>Without Mitigation</b>		<b>With Mitigation</b>		
<b>S=(E+D+R+M)*P</b>	Low Negative Impact (30)		Low Negative Impact (18)		
Was public comment received?	YES/NO. If yes, provide a bullet summary of main concerns.				
Has public comment been included in mitigation measures?	YES/NO, if NO then WHY? If YES then HOW/WHERE				
<p>Mitigation measures to reduce residual risk or enhance opportunities:</p> <p><i>Implementation of the Traffic Management Plan and Road Safety Measures</i></p> <p><i>Limit use of private cars</i></p> <p><i>Schedule development traffic movements to not coincide with existing peaks where possible</i></p> <p><i>Encourage use of public/staff transportation</i></p>					
<b>Residual impact</b>	<i>Negative, moderate and temporary</i>				

Table 8-11: Impact Summary Table for Decommission Phase – Abnormal Heavy Traffic

<b>Impact Phase:</b> Decommission					
<b>Nature of the impact:</b> Increase in abnormal traffic volumes					
<b>Description of Impact:</b> Additional heavy vehicles/E80's/Abnormal vehicles on the external road network- Potential to require additional road rehabilitation.					
<p>The impact of abnormal loads on public roads is expected to cause journey time delays and traffic congestion due to low travelling speeds of heavy vehicles transporting abnormal loads. These often occupy two standard traffic lanes and can potentially lead to incidents when travelling on single carriageways with a single lane per direction and without traffic police escorts.</p>					
<b>Impact Status:</b> Negative					
	<b>E</b>	<b>D</b>	<b>R</b>	<b>M</b>	<b>P</b>
<b>Without Mitigation</b>	National	Short Term	Recoverable	High	Probable
<b>Score</b>	4	2	3	4	3
<b>With Mitigation</b>	National	Short Term	Recoverable	Moderate	Probable
<b>Score</b>	4	2	3	3	3
<b>Significance Calculation</b>	<b>Without Mitigation</b>			<b>With Mitigation</b>	
<b>S=(E+D+R+M)*P</b>	Moderate Negative Impact (39)			Moderate Negative Impact (36)	
Was public comment received?	YES/ <b>NO</b> . If yes, provide a bullet summary of main concerns.				
Has public comment been included in mitigation measures?	YES/ <b>NO</b> , if NO then WHY? If YES then HOW/WHERE				
<p>Mitigation measures to reduce residual risk or enhance opportunities:</p> <p><i>Implementation of the Traffic Management Plan and Road Safety Measures</i></p> <p><i>Compliance to permissible heavy vehicle dimensions, permissible axle mass load on vehicles (no overloading)</i></p> <p><i>Transportation scheduling to consider the time of day when the abnormal loads would be moved</i></p> <p><i>Other alternative modes of transportation (rail where feasible) should be considered</i></p>					
Residual impact	Negative, moderate and temporary				



Table 8-12: Impact Summary Table for Decommission Phase – Dust Generation

<b>Impact Phase:</b> Decommission					
<b>Nature of the impact:</b> Impact of dust along gravel site access roads					
<b>Description of Impact:</b> Heavy vehicles are expected to cause dust along unpaved access roads to the site. This can affect the air quality and visibility for nearby residents and road users. Larger vehicles generate more dust which can limit the ability of other vehicles to overtake due to poor visibility.					
<b>Impact Status:</b> Negative					
	<b>E</b>	<b>D</b>	<b>R</b>	<b>M</b>	<b>P</b>
<b>Without Mitigation</b>	Site	Immediate	Recoverable	Moderate	Probable
<b>Score</b>	1	1	3	3	3
<b>With Mitigation</b>	Site	Immediate	Reversible	Low	Low Probability
<b>Score</b>	1	1	1	2	2
<b>Significance Calculation</b>	<b>Without Mitigation</b>		<b>With Mitigation</b>		
<b>S=(E+D+R+M)*P</b>	Low Negative Impact (24)		Low Negative Impact (14)		
Was public comment received?	YES/ <b>NO</b> . If yes, provide a bullet summary of main concerns.				
Has public comment been included in mitigation measures?	YES/ <b>NO</b> , if NO then WHY? If YES then HOW/WHERE				
Mitigation measures to reduce residual risk or enhance opportunities: <i>Dust control measures such as regular wet grading and wetting for dust suppression to minimize the negative impact</i>					
Residual impact	Yes, but acceptable.				

Table 8-13: Impact Summary Table for Decommission Phase – Deterioration of Surrounding Road Network

<b>Impact Phase:</b> Decommission					
<b>Nature of the impact:</b> Deterioration of surrounding road network					
<p><b>Description of Impact:</b> Heavy vehicle traffic during construction of the development is expected to cause additional wear and tear on the surrounding road network. Gravel access roads to the sites are also expected to sustain damage during the construction phase of the project.</p> <p>Abnormal loads can exert more pressure on road surfaces and infrastructure, leading to increased maintenance costs and reduced road network lifespan.</p>					
<b>Impact Status:</b> Negative					
	<b>E</b>	<b>D</b>	<b>R</b>	<b>M</b>	<b>P</b>
<b>Without Mitigation</b>	Local	Short Term	Recoverable	Moderate	Probable
<b>Score</b>	2	2	3	3	3
<b>With Mitigation</b>	Site	Immediate	Reversible	Low	Low Probability
<b>Score</b>	1	1	1	2	2
<b>Significance Calculation</b>	<b>Without Mitigation</b>			<b>With Mitigation</b>	
<b>S=(E+D+R+M)*P</b>	Low Negative Impact (30)			Low Negative Impact (10)	
Was public comment received?	YES/ <b>NO</b> . If yes, provide a bullet summary of main concerns.				
Has public comment been included in mitigation measures?	YES/ <b>NO</b> , if NO then WHY? If YES then HOW/WHERE				
<p>Mitigation measures to reduce residual risk or enhance opportunities:</p> <p><i>Limiting the number and frequency of heavy and overloaded vehicles where possible</i></p> <p><i>Undertaking regular maintenance, rehabilitation and upgrading substandard pavement conditions</i></p>					
Residual impact	<i>Positive, roads will remain in better conditions post implementation of mitigation measures</i>				

## 8.4 Assessment of Cumulative Development Impacts

As per the NEMA EIA Reg GN R982 of 2014, in relation to an activity, cumulative impact means “the past, current and reasonably foreseeable future impact of an activity, considered together with the impact of activities associated with that activity, that in itself may not be significant, but may be significant when added to the existing and reasonably foreseeable impacts eventuating from similar or diverse activities”.

Table 8-14 and Figure 8-1 indicate wind and solar developments with an approved Environmental Authorisation or applications under consideration and proposed developments within 30 km of the proposed area. Cumulative impacts of these are assessed in the following subsections.

Table 8-14: Wind and Solar developments with an approved Environmental Authorisation or Application

No.	EIA Reference No	Classification	Status of Application	Distance from proposed area (km)
1	14/12/16/3/3/2/810	Solar PV	Approved	20.5
2	12/12/20/2210	Solar PV	Approved	23.9
3	12/12/20/2019	Solar PV	Approved	26.2
4	12/12/20/2210/AM2	Solar PV	Approved	23.9
5	12/12/20/1956	Solar PV	Approved	16.4
6	N/A	Solar PV	Proposed	9.5
7	N/A	Wind	Proposed	13.5

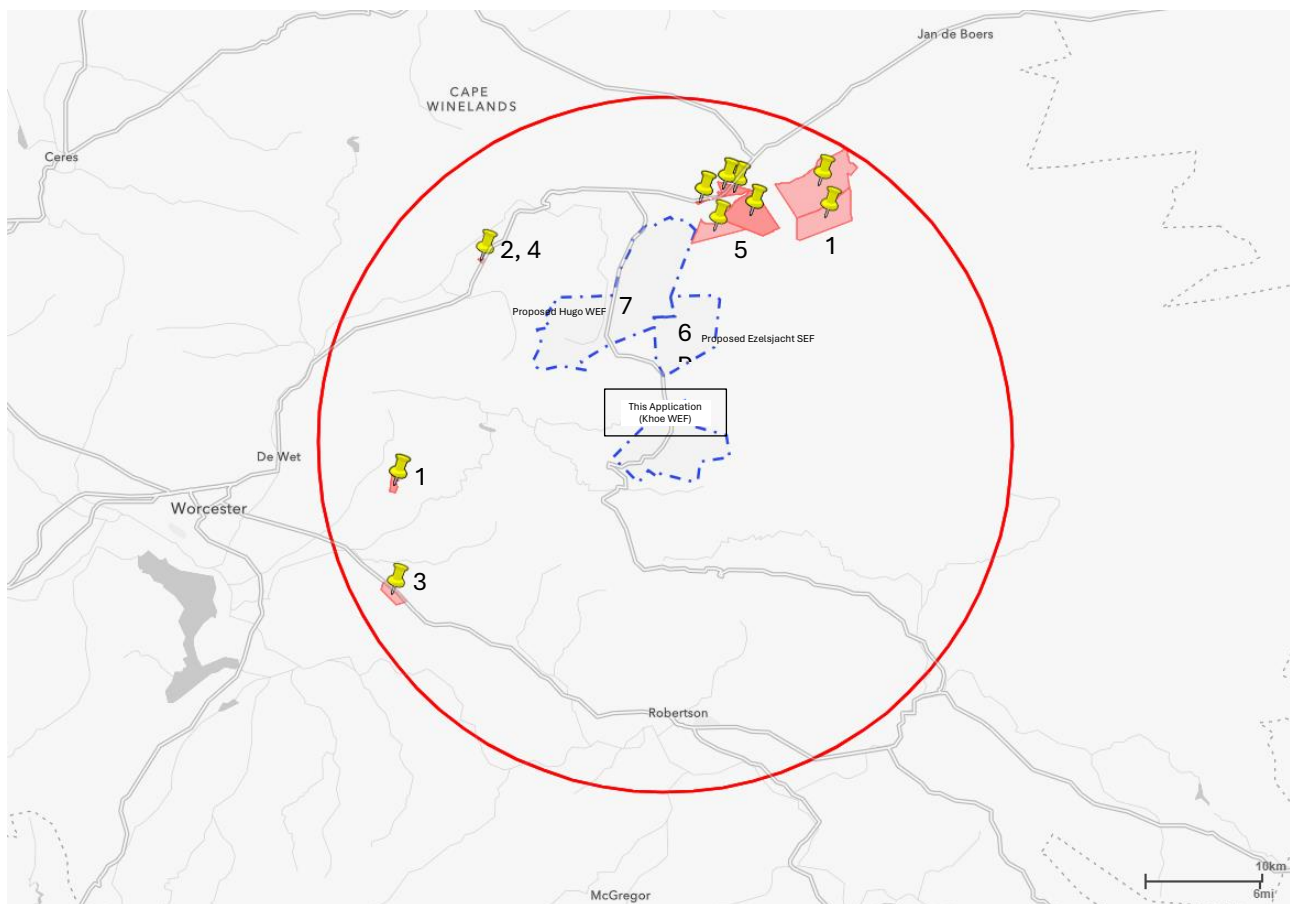

Figure 8-1: Wind and Solar developments with an approved Environmental Authorisation or Applications under consideration within 30 km of the proposed area

Table 8-15: Cumulative Impact – Increased General Traffic

<b>Cumulative Impact:</b> Increase in general peak hour traffic volumes					
<p><b>Description of Cumulative Impact:</b> Increased traffic on the route and access points to site - Potential to be greater than what the existing road capacity of the local road network can handle in order to operate at an acceptable level of service.</p> <p>This impact relates to potential disruption of traffic on local, regional and national roads. The severity of the impacts will depend on the order of the road (how many lanes, lanes width, length, turns, etc.), the receiving environment and vicinity of land uses and towns.</p> <p>Additional traffic on the road network could result in changes to the operations of that road network, intersection capacity, such as increased congestion, delays, and accidents.</p>					
<b>Impact Status:</b> Detail of the impact is Positive, Neutral or Negative					
	<b>E</b>	<b>D</b>	<b>R</b>	<b>M</b>	<b>P</b>
<b>Without Enhancement</b>	Regional	Short Term	Recoverable	Probable	Probable
<b>Score</b>	3	2	3	3	3
<b>With Enhancement</b>	Local	Short Term	Recoverable	Probable	Probable
<b>Score</b>	2	2	3	3	3
<b>Significance Calculation</b>	<b>Without Enhancement</b>		<b>With Enhancement</b>		
<b>S=(E+D+R+M)*P</b>	Moderate Negative Impact (33)		Low Negative Impact (30)		
Can Impacts be Enhanced?	<b>YES/NO and HOW/WHY</b>				
<p>Enhancement:</p> <p><i>Implementation of the Traffic Management Plan and Road Safety Measures</i></p> <p><i>Limit use of private cars</i></p> <p><i>Schedule development traffic movements to not coincide with existing peaks where possible</i></p> <p><i>Encourage use of public/staff transportation</i></p>					
Residual impact	<i>Negative to Significant</i>				



Table 8-16: Cumulative Impact – Abnormal Heavy Traffic

<b>Cumulative Impact: Increase in abnormal traffic volumes</b>					
<b>Description of Cumulative Impact:</b> Additional heavy vehicles/E80's/Abnormal vehicles on the external road network- Potential to require additional road rehabilitation.					
The impact of abnormal loads on public roads is expected to cause journey time delays and traffic congestion due to low travelling speeds of heavy vehicles transporting abnormal loads. These often occupy two standard traffic lanes and can potentially lead to incidents when travelling on single carriageways with a single lane per direction and without traffic police escorts.					
<b>Impact Status:</b> Detail of the impact is Positive, Neutral or Negative					
	<b>E</b>	<b>D</b>	<b>R</b>	<b>M</b>	<b>P</b>
<b>Without Enhancement</b>	Regional	Short Term	Recoverable	High	Highly Probable
<b>Score</b>	4	2	3	4	4
<b>With Enhancement</b>	Regional	Short Term	Recoverable	Probable	Probable
<b>Score</b>	3	2	3	3	3
<b>Significance Calculation</b>	<b>Without Enhancement</b>		<b>With Enhancement</b>		
<b>S=(E+D+R+M)*P</b>	Moderate Negative Impact (39)		Moderate Negative Impact (33)		
Can Impacts be Enhanced?	<b>YES/NO and HOW/WHY</b>				
Enhancement: <i>Implementation of the Traffic Management Plan and Road Safety Measures</i> <i>Compliance to permissible heavy vehicle dimensions, permissible axle mass load on vehicles (no overloading)</i> <i>Transportation scheduling to consider the time of day when the abnormal loads would be moved</i> <i>Other alternative modes of transportation (rail where feasible) should be considered</i>					
Residual impact	Negative to Very Significant				

Table 8-17: Cumulative Impact – Dust

<b>Cumulative Impact:</b> Impact of dust along gravel site access roads					
<b>Description of Cumulative Impact:</b> Heavy vehicles are expected to cause dust along unpaved access roads to the site. This can affect the air quality and visibility for nearby residents and road users. Larger vehicles generate more dust which can limit the ability of other vehicles to overtake due to poor visibility.					
<b>Impact Status:</b> Detail of the impact is Positive, Neutral or Negative					
	<b>E</b>	<b>D</b>	<b>R</b>	<b>M</b>	<b>P</b>
<b>Without Enhancement</b>	Site	Immediate	Recoverable	Moderate	Probable
<b>Score</b>	1	1	3	3	3
<b>With Enhancement</b>	Site	Immediate	Recoverable	Low	Low Probability
<b>Score</b>	1	1	1	2	2
<b>Significance Calculation</b>	<b>Without Enhancement</b>		<b>With Enhancement</b>		
<b>S=(E+D+R+M)*P</b>	Low Negative Impact (24)		Low Negative Impact (10)		
Can Impacts be Enhanced?	<b>YES/NO and HOW/WHY</b>				
Enhancement: <i>Dust control measures such as regular wet grading and wetting for dust suppression to minimize the negative impact</i>					
Residual impact	<i>Negligible</i>				

Table 8-18: Cumulative Impact – Deterioration of surrounding road network

<b>Cumulative Impact: Deterioration of surrounding road network</b>					
<p><b>Description of Cumulative Impact:</b> Heavy vehicle traffic during construction of the development is expected to cause additional wear and tear on the surrounding road network. Gravel access roads to the sites are also expected to sustain damage during the construction phase of the project.</p> <p>Abnormal loads can exert more pressure on road surfaces and infrastructure, leading to increased maintenance costs and reduced road network lifespan.</p>					
<b>Impact Status:</b> Detail of the impact is Positive, Neutral or Negative					
	<b>E</b>	<b>D</b>	<b>R</b>	<b>M</b>	<b>P</b>
<b>Without Enhancement</b>	Regional	Short Term	Recoverable	Moderate	Probable
<b>Score</b>	1	1	3	4	3
<b>With Enhancement</b>	Local	Short Term	Recoverable	Low	Probable
<b>Score</b>	1	1	2	3	3
<b>Significance Calculation</b>	<b>Without Enhancement</b>		<b>With Enhancement</b>		
<b>S=(E+D+R+M)*P</b>	Low Negative Impact (27)		Low Negative Impact (21)		
Can Impacts be Enhanced?	<b>YES/NO and HOW/WHY</b>				
<p>Enhancement:</p> <p><i>Limiting the number and frequency of heavy and overloaded vehicles where possible</i></p> <p><i>Undertaking regular maintenance, rehabilitation and upgrading substandard pavement conditions</i></p>					

## 9 Conclusions and Recommendations

Based on the information detailed in this report, the following conclusions are drawn:

- The proposed development and final layout can be supported from a traffic engineering point of view.
- The base year and forecast year road capacity analysis has indicated that the proposed development will have little to no significant impact on the existing road network capacity and intersection operational performance.
- Given the findings of this report, it is recommended that the proposed development be considered favourably from a traffic engineering point of view as the intended construction will have no significant negative impact on the surrounding road network.

The following recommendations are made:

- A comprehensive route assessment of the entire transportation route to verify clearance, load bearing and sweeping radius distances is recommended.
- The main access to the development is proposed approximately 1.6 km east of the existing Main Road R319/DR01428 intersection. This is essentially the alternative location of the associated WEF facility infrastructure based on safety considerations and mitigation measures outlined in the report.
- It is recommended that the access points be priority controlled and widened to allow for acceleration lane and dedicated right turn lane off the main road, which will incorporate the turning characteristics of the expected abnormal vehicles.
- Clearance permits will be required for the transport of the WT components.
- It is recommended that applications for Abnormal Permits be lodged to the Department of Transport and Public Works, Eskom, and Telkom (where affected) at the time of construction.



## Appendix A – Project Description: Khoe

## SPECIFICATIONS OF PROPOSED DEVELOPMENT



WEF Technical Details Components	Description / Dimensions - Hugo	Description / Dimensions - Khoe
<b>Maximum Generation Capacity</b>	up to 360MW	up to 290MW
<b>Type of technology</b>	Onshore Wind	Onshore Wind
<b>Number of Turbines</b>	Up to 48	Up to 38
<b>WTG Hub Height from ground level</b>	up to 150m	up to 150m
<b>Blade Length</b>	up to 100m	up to 100m
<b>Rotor Diameter</b>	up to 200m	up to 200m
<b>Structure height (Tip Height)</b>	up to 250m	up to 250m
<b>Structure orientation</b>	Wind regiment dependant	Wind regiment dependant
<b>Area occupied by both permanent and construction laydown areas</b>	See layout	See layout
<b>Operations and maintenance buildings (O&amp;M building) with parking area</b>	up to 1 HA	up to 1 HA
<b>Site Access</b>	Via the R318	Via the R318
<b>Area occupied by inverter transformer stations/substations</b>	up to 2.5 HA	up to 2.5 HA

<b>WEF Technical Details Components</b>	<b>Description / Dimensions - Hugo</b>	<b>Description / Dimensions - Khoe</b>
<b>Capacity of on-site substation</b>	132/33kv	132/33kv
<b>Battery Energy Storage System footprint</b>	up to 5 HA	up to 5 HA
<b>BESS type</b>	Lithium-ion or Redox-flow technology, depending on the most feasible at the time of implementation	Lithium-ion or Redox-flow technology, depending on the most feasible at the time of implementation
<b>BESS Alternatives (site, technology, design and layout)</b>	Same as above. See layout for design and position	Same as above. See layout for design and position
<b>Length of internal roads</b>	TBD	TBD
<b>Width of internal roads</b>	Access roads to the site and between project components with a width of approximately 4.5 m and a servitude of 13.5 m.	Access roads to the site and between project components with a width of approximately 4.5 m and a servitude of 13.5 m.
<b>Proximity to grid connection</b>	TBD	TBD
<b>Internal Cabling</b>	Cabling between the turbines, to be laid underground where practical.	Cabling between the turbines, to be laid underground where practical.
<b>Height of fencing</b>	TBD	TBD
<b>Type of fencing</b>	TBD	TBD
<b>Water supply, volumes required</b>	±26500m <sup>3</sup> for the construction, commissioning and test phase (±26 months), the majority being consumed during year-one of the construction. ±90m <sup>3</sup> /annum for the life-of-WEF (20-25 years)	±24500m <sup>3</sup> for the construction, commissioning and test phase (±26 months), the majority being consumed during year-one of the construction. ±90m <sup>3</sup> /annum for the life-of-WEF (20-25 years)
<b>Waste Management, waste volumes, and how will it be managed</b>	To be determined at a later stage- either through Municipal channels or private	To be determined at a later stage- either through Municipal channels or private

WEF Technical Details Components	Description / Dimensions - Hugo	Description / Dimensions - Khoe
<b>Details on where material and equipment will be sourced for construction</b>	To be determined upon construction and latest market availability	To be determined upon construction and latest market availability
<b>Employment opportunities during construction and operations (maintenance) Skilled, semi-skilled, unskilled employees</b>	Low skilled: up to ( $\pm$ 55%) Semi-skilled: up to ( $\pm$ 30%) Skilled: up to ( $\pm$ 15%)	Low skilled: up to ( $\pm$ 55%) Semi-skilled: up to ( $\pm$ 30%) Skilled: up to ( $\pm$ 15%)

## PROJECT DESCRIPTION

### *Hugo WEF*

The proposed Hugo WEF will comprise up to 48 turbines with a maximum output capacity of up to 360 MW with an anticipated lifespan of xxx years. The WEF will be located on the following land parcels: RE 147; RE/172; 0/173; RE/174; and 9/148 (See table below). The final design which will be requested for approval in the EA, will be determined based on the outcome of the specialist studies undertaken for the EIA phase of the development. The proposed turbine footprint and associated facility infrastructure will cover an area of up to 7900 ha, depending on the final design.

It is proposed that an on-site substation with a capacity up 132 kV with an up to 33 kV overhead / underground powerline will be installed. It is unknown at this stage how long the connection to the grid will be, or what route the cabling will be installed.

### *Khoe WEF*

The proposed Khoe WEF will comprise up to 38 turbines with a maximum output capacity of up to 290 MW with an anticipated lifespan of xxx years. The WEF will be located on the following land parcels: 1/38; 2/38; 11/38; 193; and RE/37 (see table below). The final design which will be requested for approval in the EA, will be determined based on the outcome of the specialist studies undertaken for the EIA phase of the development. The proposed turbine footprint and associated facility infrastructure will cover an area of up to 4113 ha, depending on the final design.

It is proposed that an on-site substation with a capacity up 132 kV with an up to 33 kV overhead / underground powerline will be installed. It is unknown at this stage how long the connection to the grid will be, or what route the cabling will be installed.

## LANDOWNER INFORMATION

---

### Hugo WEF

---

Landowner	Farm Name	Farm No.	Portion No.	SG Code
Blue Dot Prop 424	Ou de Kraal	145	RE	
Blue Dot Prop 424	Stinkfonteins Berg	147	RE	
Blue Dot Prop 424	Stinkfontein	172	RE	
Marius Hugo	Driehoek	173	0	
Marius Hugo	Presents Kraal	174	RE	
Dirk Uys Boerdery PTY LTD	Helpmakeer	148	9	
Overhead Transmission Line				
Marius Hugo	Presents Kraal	174	RE	
Dirk Uys	Helpmakeer	148	9	

### Khoe WEF

Landowner	Farm Name	Farm No.	Portion No.	SG Code
Sandvlei Trust	Eendragt	38	1	
Hennie De Kock	Eendragt	38	2	
Hennie De Kock	Eendragt	38	11	
Johan Le Roux	Plaas 193	193		
Sophia Le Roux	Eendragt	37	RE	
Overhead Transmission Line				
Hennie De Kock	Eendragt	38	11	
Johan Le Roux	Plaas 193	193	9	
Sophia Le Roux	Eendragt	37	RE	



## Appendix B – WTG Layout Khoe WEF

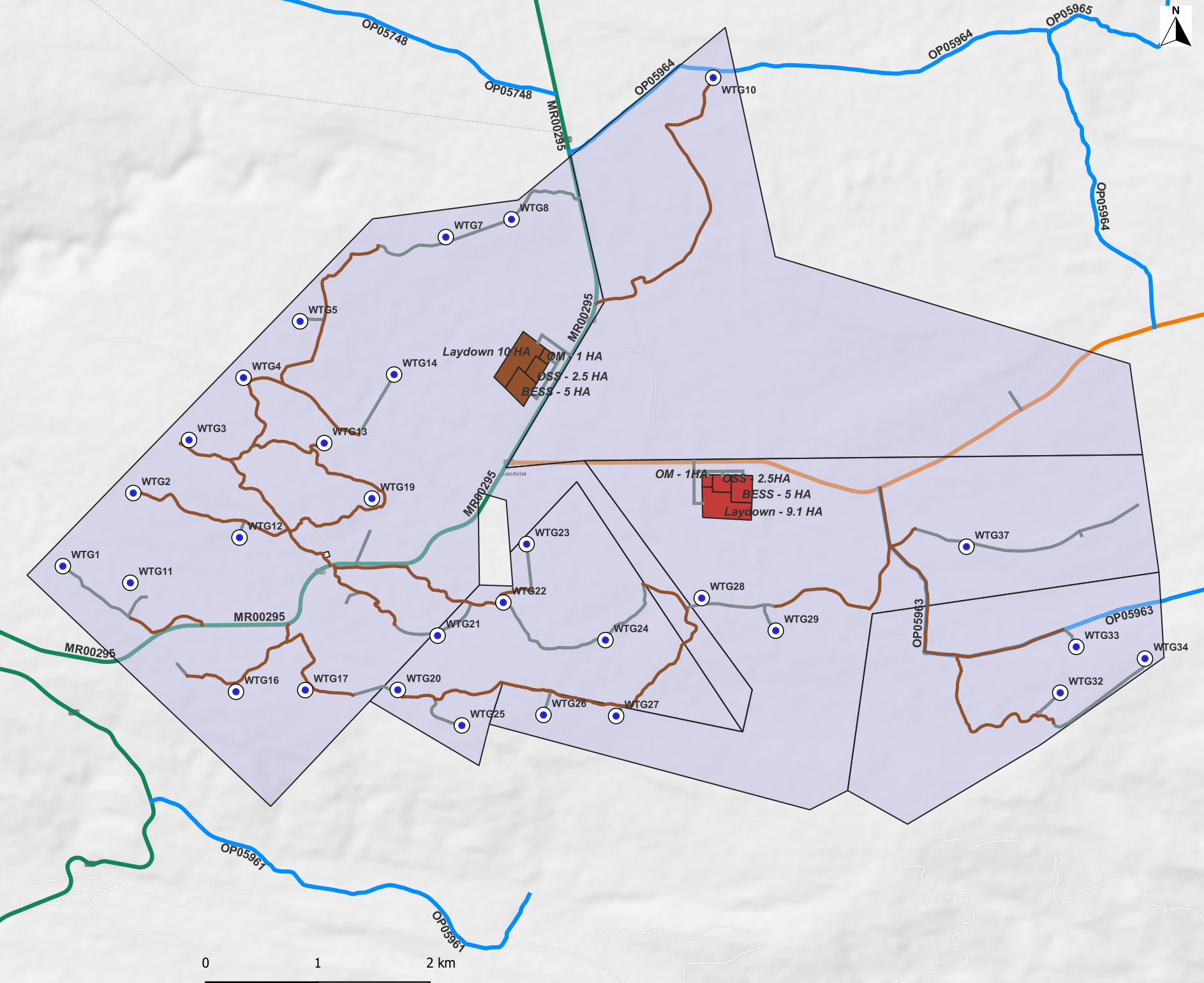

**Legend**

- Project boundary
- WTGs
- Internal Roads**
  - Existing Roads
  - New Road
- Provincial Road Network**
  - Main Roads
    - MR00295 (R318)
  - Divisional Roads
    - DR01428
    - DR01402
  - Minor Roads
    - OP05748
    - OP05958
    - OP05959
    - OP05960
    - OP05961
    - OP05962
    - OP05963
    - OP05964
    - OP05965
    - OP06039
    - OP06041
- Source Esri Street

Distance from ALL proclaimed road reserve boundaries  
 Min required toppling distance plus 5m  
 (250+5m = 255m)

WTG No.	Distance (m)	Road Name
1	1016.779	MR00295
2	1759.52	MR00295
3	1662.987	MR00295
4	2399.969	MR00295
5	2209.824	MR00295
7	1466.978	MR00295
8	609.373	MR00295
10	49.73	OP05964
11	513.001	MR00295
12	718.228	MR00295
13	1281.028	MR00295
14	1285.87	MR00295
16	580.946	MR00295
17	583.975	MR00295
19	554.158	MR00295
20	1097.383	MR00295
21	684.708	MR00295
22	801.355	MR00295
23	492.942	MR00295
24	1681.568	DR01428
25	1724.326	MR00295
26	1871.79	MR00295
27	2167.775	MR00295
28	1208.002	DR01428
29	1355.439	DR01428
32	501.293	OP05963
33	167.435	OP05963
34	446.769	OP05963
37	460.24	OP05963







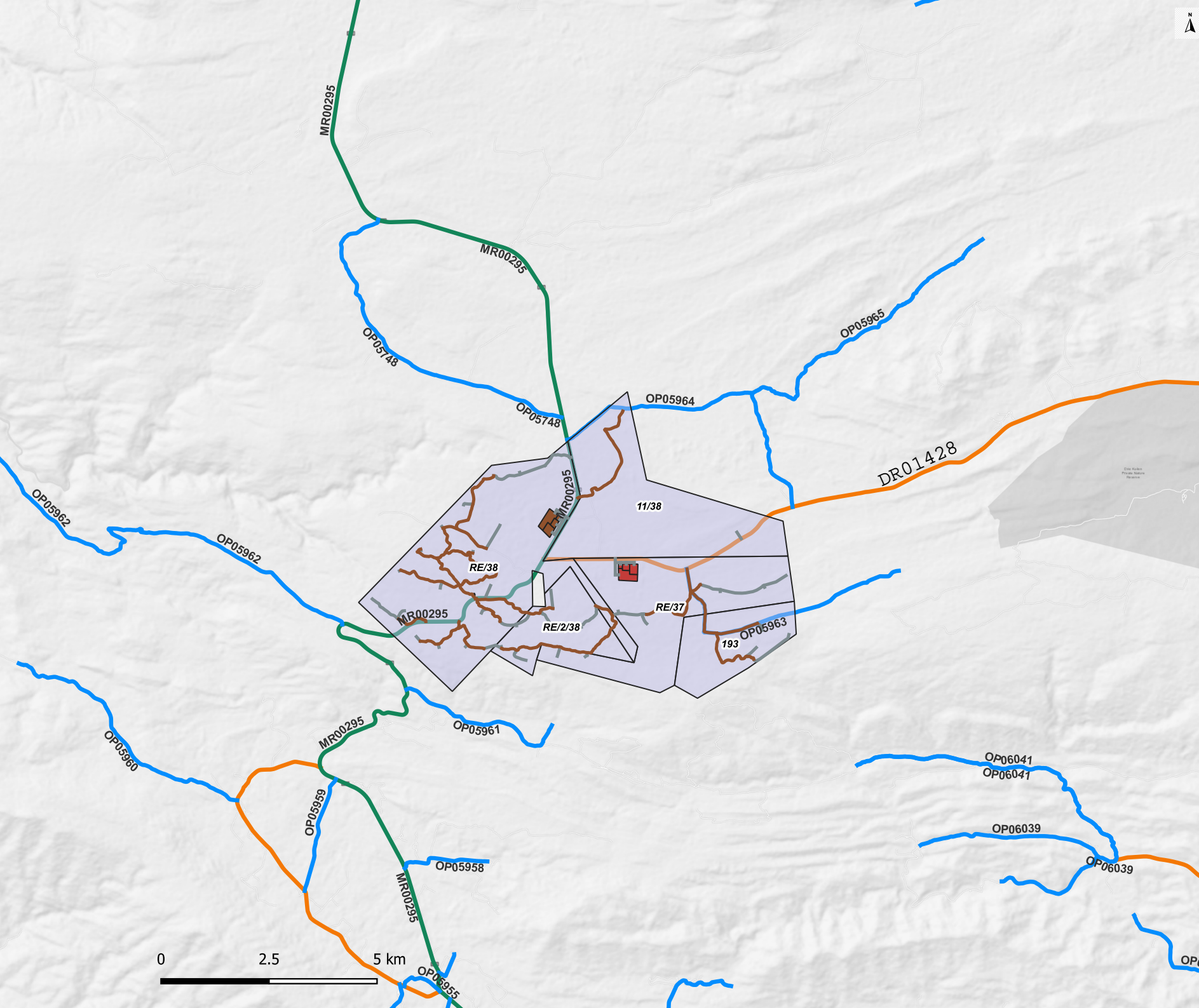











**Khoe WTG Layout**



## Appendix C – Existing Surrounding Road Network



**Legend**

-  Project boundary
-  WTGs
- Internal Roads**
  -  Existing Roads
  -  New Road
- Provincial Road Network**
  - Main Roads**
    -  MR00295 (R318)
  - Divisional Roads**
    -  DR01428
    -  DR01402
  - Minor Roads**
    -  OP05748
    -  OP05958
    -  OP05959
    -  OP05960
    -  OP05961
    -  OP05962
    -  OP05963
    -  OP05964
    -  OP05965
    -  OP06039
    -  OP06041
-  Source Esri Street

**Khoe Road Network**



Member of the Surbana Jurong Group



### 1. N1 National Road



### 2. R318 (MR00295) Provincial Main Road



### 3. DR01442 Provincial Divisional Road





#### 4. OP05749 Provincial Minor Road



#### 5. OP05748 Provincial Minor Road



## Appendix D – Existing Intersections

Intersection N1 and R381 (MR00295)



2. Intersection R318 (MR00295) and DR01442



3. Intersection R318 (MR00295) and OP05749



4. Intersection R318 (MR00295) and OP05748





5. Intersection R318 (MR00295) and DR01428



6. Intersection R318 (MR00295) and OP05962



## Appendix E – Existing Traffic



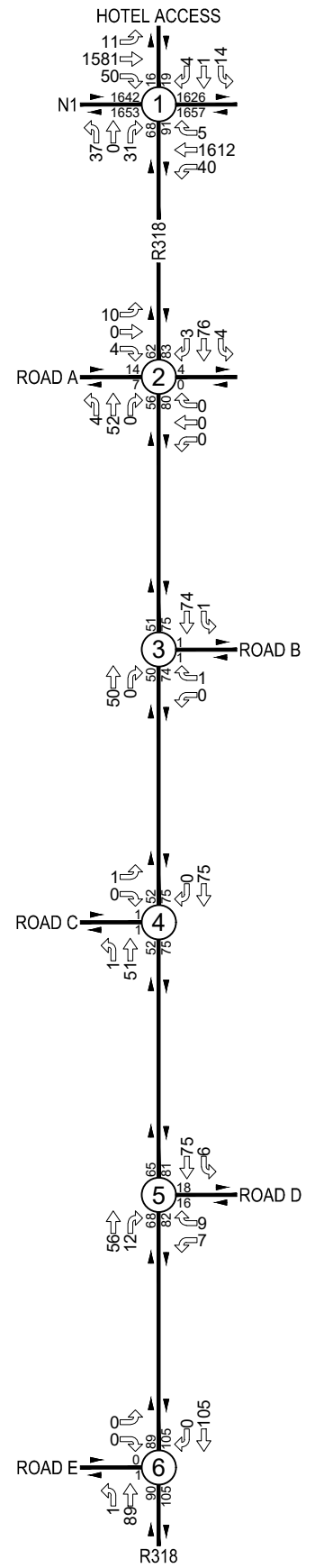
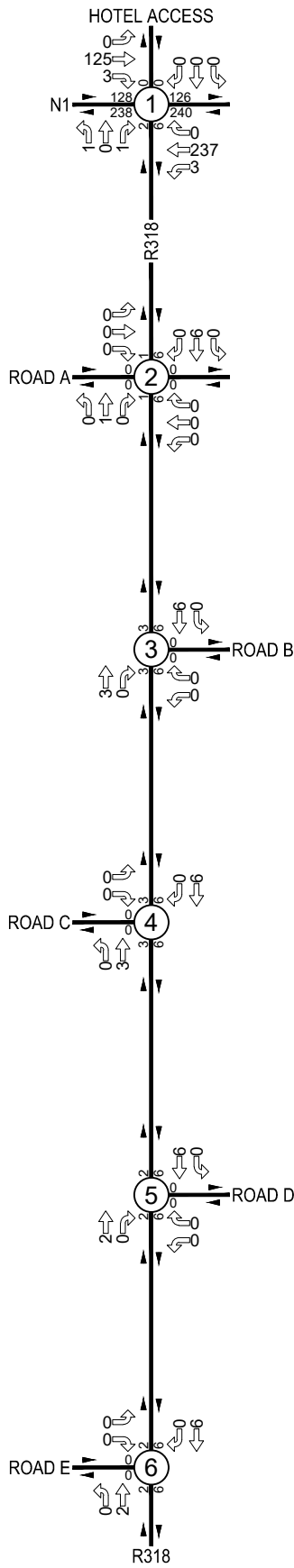
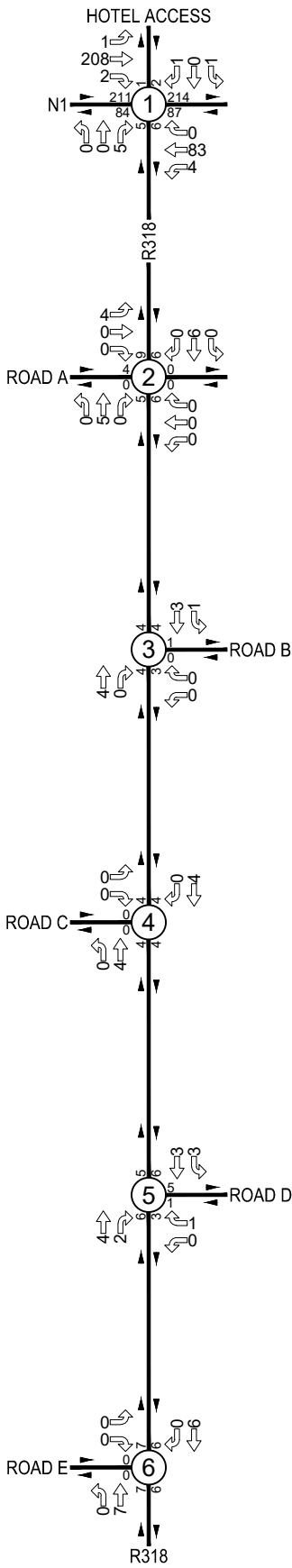

## Appendix F – Provincial Roads and SANRAL Counts

## Appendix G – Building Lines

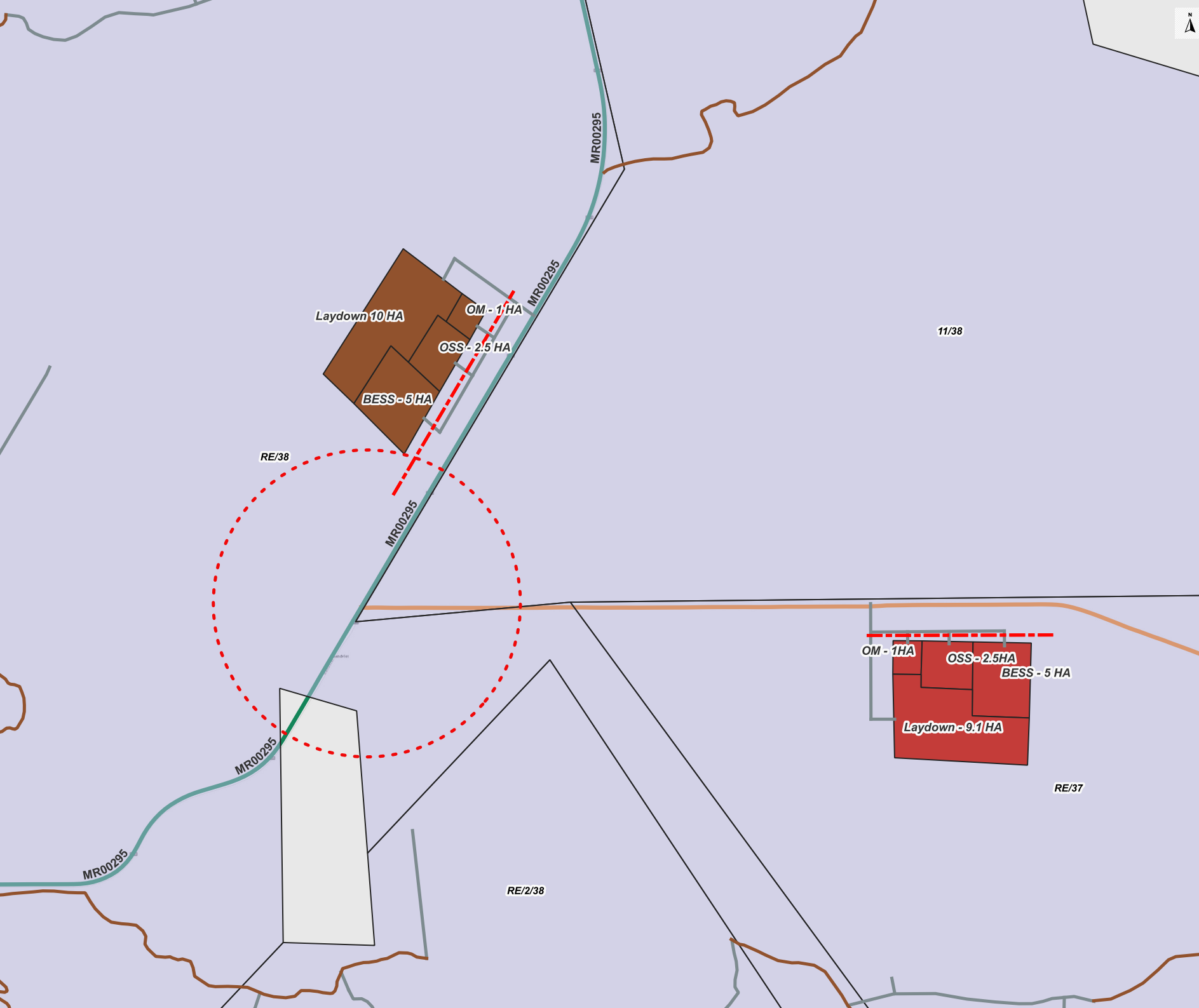

- Legend**
- Associated Infrastructure – Preferred
  - Associated Infrastructure – Alternative
- Internal Roads**
- Existing Roads
  - New Road
- Provincial Road Network**
- Main Roads
  - Minor Roads
- Building restrictions**
- Building Restriction Line (500m) from the centreline's of intersecting trunk, main, and divisional roads; and where these roads intersect other roads.
  - Building Restriction Line (95m) from Centreline of the Road Reserve
- Source Esri Street

0 250 500 m

**Laydown Area & Buildings**



## Appendix H – Standard Plans



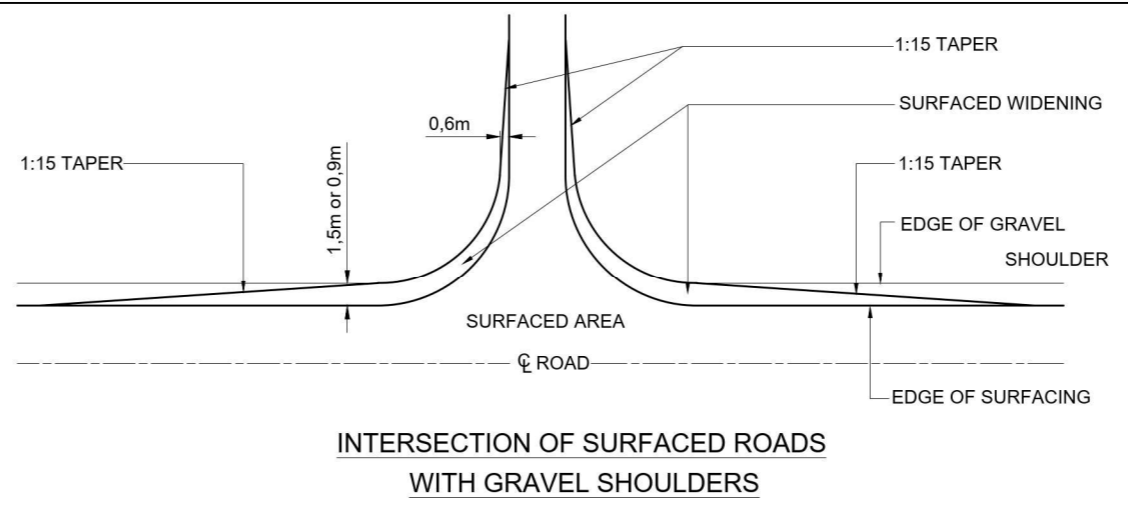
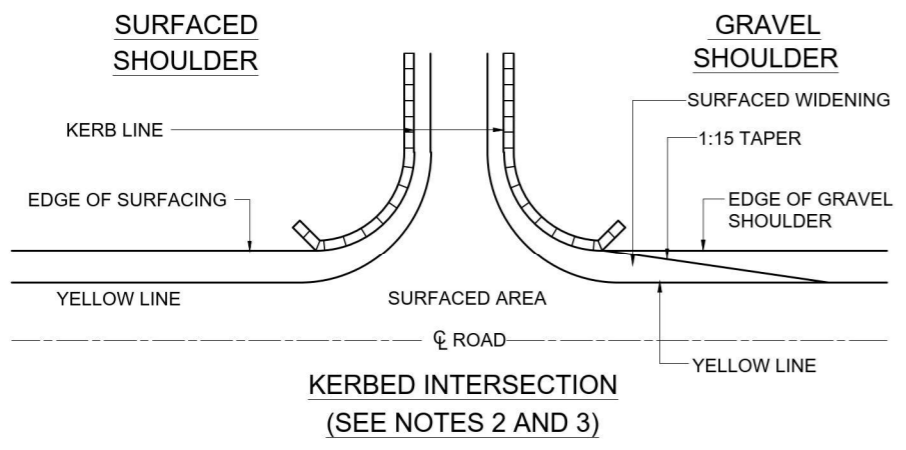

- NOTES :
1. THE STANDARD GATE IS TO BE LOCATED AT END OF RAMP IN FILL AND AT THE BUILDING LINE IN CUT. THE WIDTH OF THE GATE TO SUIT FARM EQUIPMENT.
  2. FOR ROADS WITH SURFACED SHOULDERS THE KERB LAYOUT MUST BE DESIGNED AND CONSTRUCTED SO THAT THE KERBS LINE UP WITH THE EDGE OF SURFACING.
  3. FOR ROADS WITH GRAVEL SHOULDERS THE KERB LAYOUT MUST BE DESIGNED AND CONSTRUCTED SO THAT THE KERBS LINE UP WITH THE OUTSIDE EDGE OF USABLE SHOULDER WITH A SURFACED TAPER EXTENDING BEYOND THE KERB TO THE NORMAL CARRIAGEWAY SURFACED WIDTH.
  4. WHERE TWO ROADS INTERSECT THE NUMERICAL DIFFERENCE OF THE GRADIENTS (ROLL OVER) SHOULD NOT EXCEED 10% WITH A MAXIMUM SUPERELEVATION OF 6% ON THE MAIN ROAD.
  5. MAXIMUM APPROACH GRADIENT TO BE 4% UPGRADE AND 6% DOWNGRADE.
  6. THE BELLMOUTH RADIUS OF 15m IS ONLY APPLICABLE WHERE SIGNIFICANT SU + T VEHICLES USE THE ACCESS.

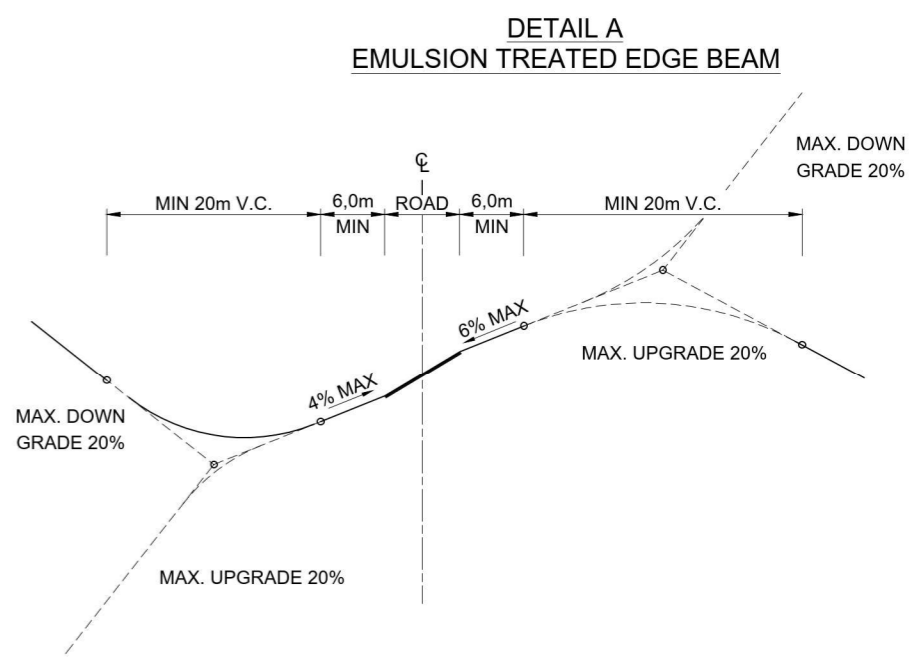
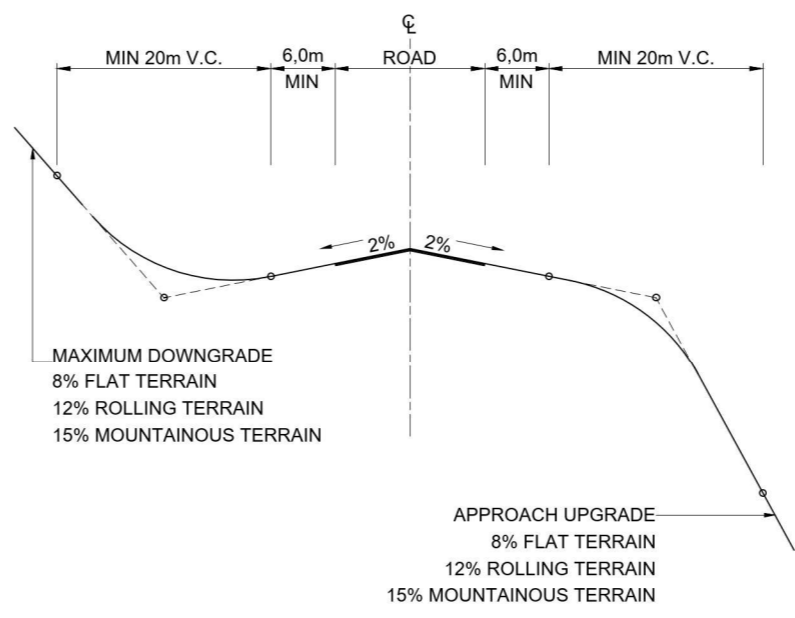
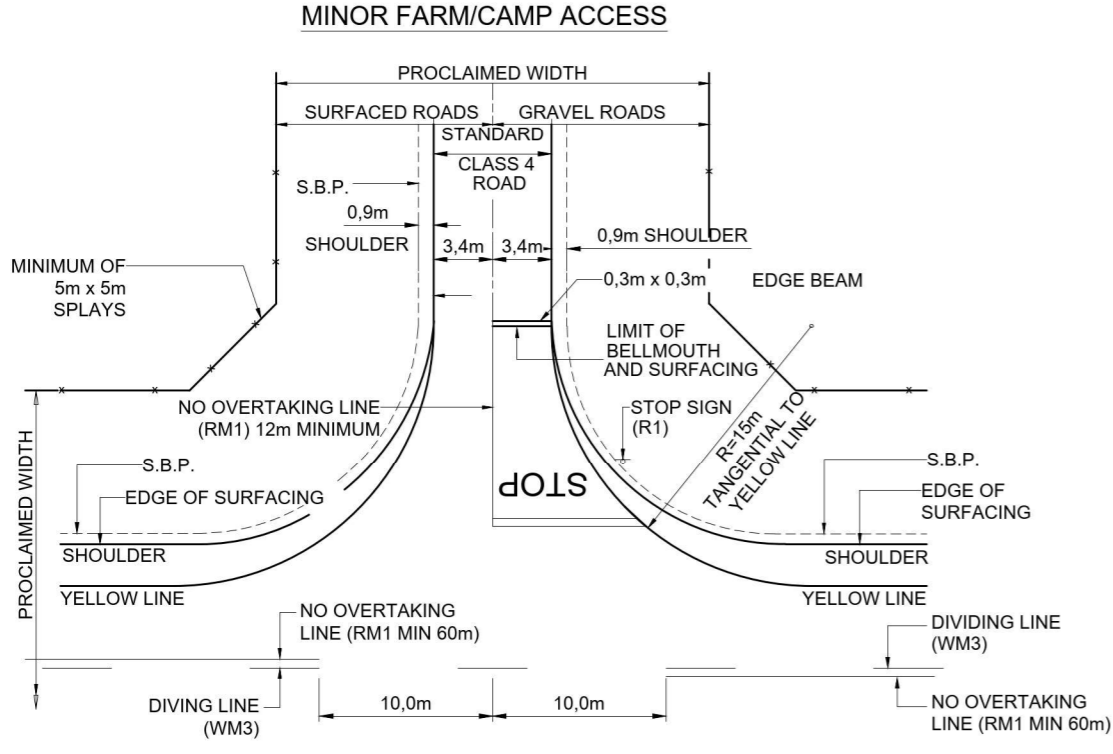
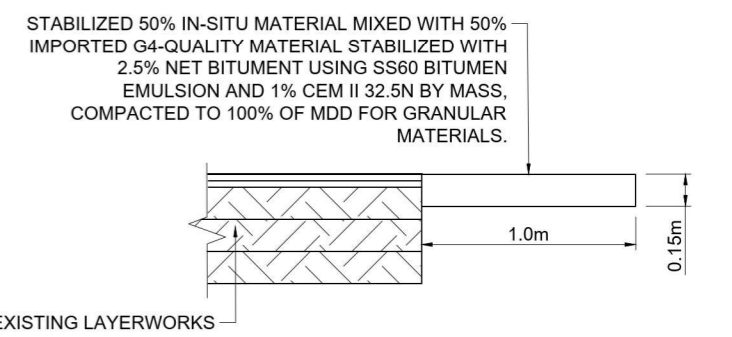
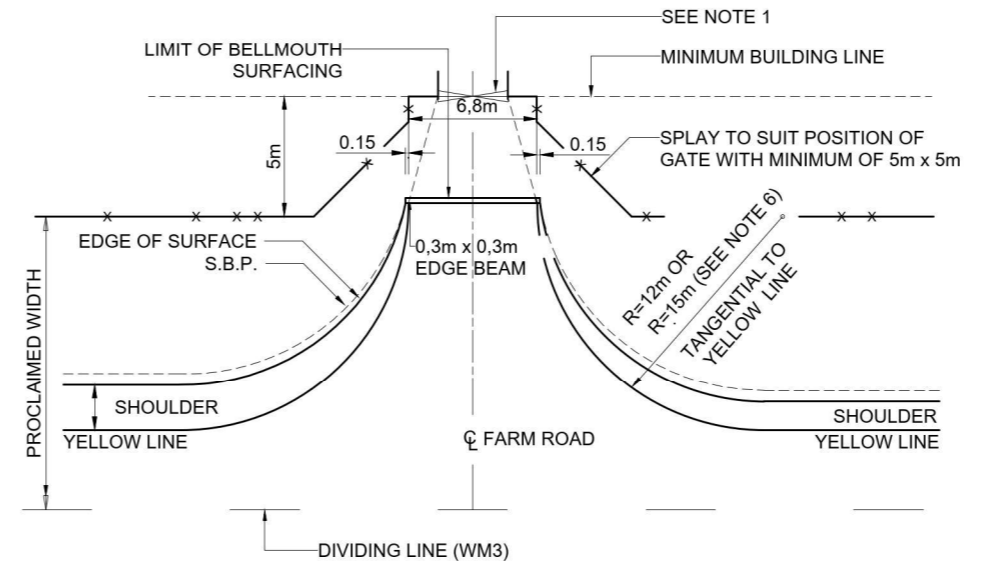
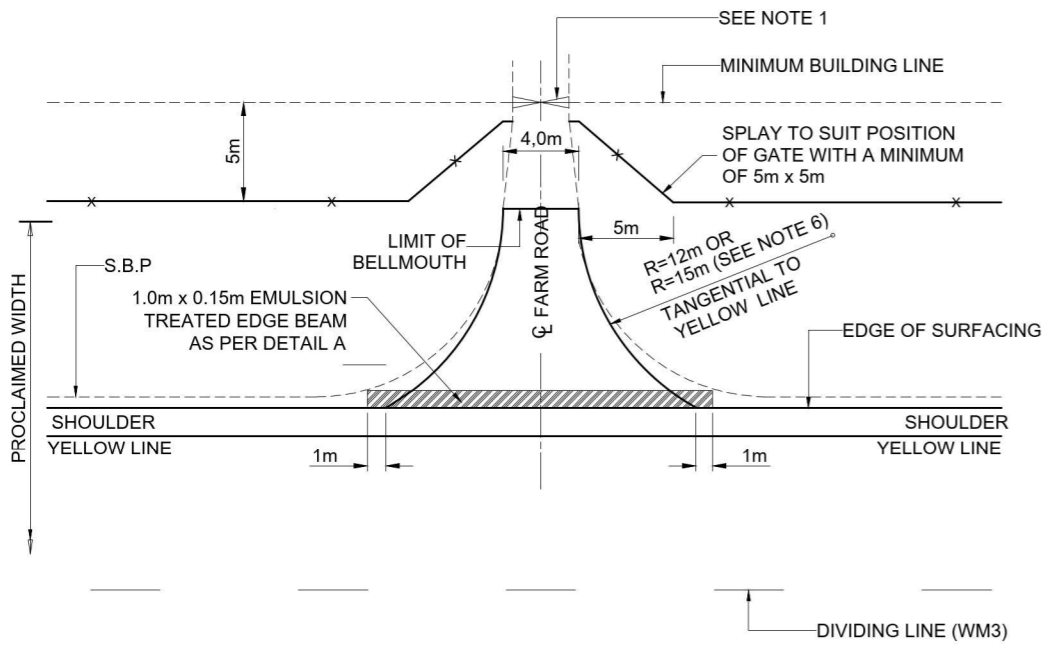

No.	DATE	ADDITIONS AND AMENDMENTS
0	OCT - 2023	ORIGINAL VERSION

- NOTES :**
- CUT SLOPE :**  
 1:0,25 IN ROCK  
 1:1 IN SOFT ROCK  
 1:1,50 IN SOFT MATERIAL OR AS DIRECTED  
 WHERE CUTS ARE DEEPER THAN 4m, BENCHES MAY BE REQUIRED AS DIRECTED.  
 FOR CUTS DEEPER THAN 6m IN CLAY, REFER TO MATERIALS ENGINEER.
  - FILL SLOPES :**  
 1:2 FILL LESS THAN 4,0m IN HEIGHT  
 1:1,5 FILL GREATER THAN 4,0m IN HEIGHT OR AS DIRECTED  
 FILLS GREATER THAN 6m IN CLAY SHALL BE REFERRED TO MATERIALS ENGINEER  
 BENCHES IN FILL TO BE CONSTRUCTED AT 8m INTERVALS BELOW S.B.P.  
 FILLS GREATER THAN 3,5m WITH 1:1,5 SLOPES TO BE EVALUATED FOR GUARDRAIL WARRANTS
  - SIDE DRAIN DEPTH :**  
 LAYERWORK DEPTH PLUS 200mm OR AS DIRECTED BY MATERIALS ENGINEER.

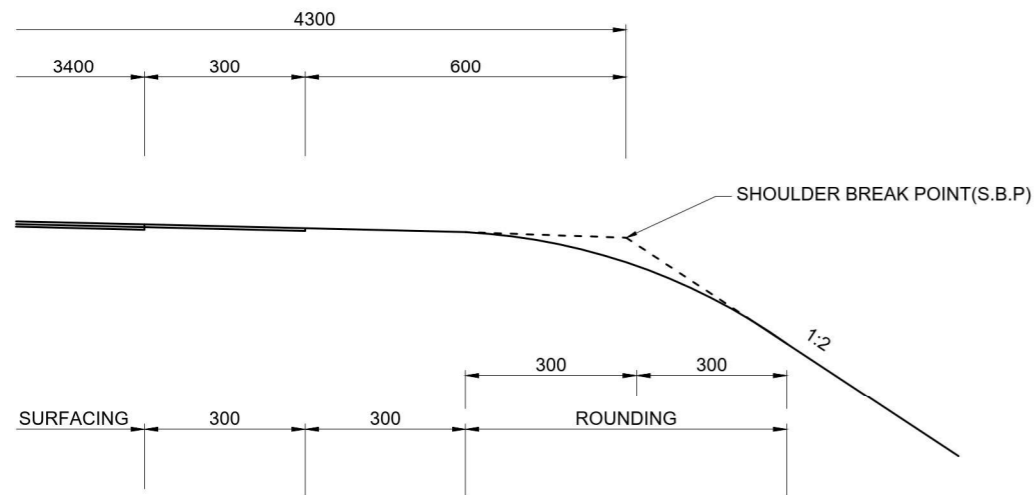

**DETAIL A**

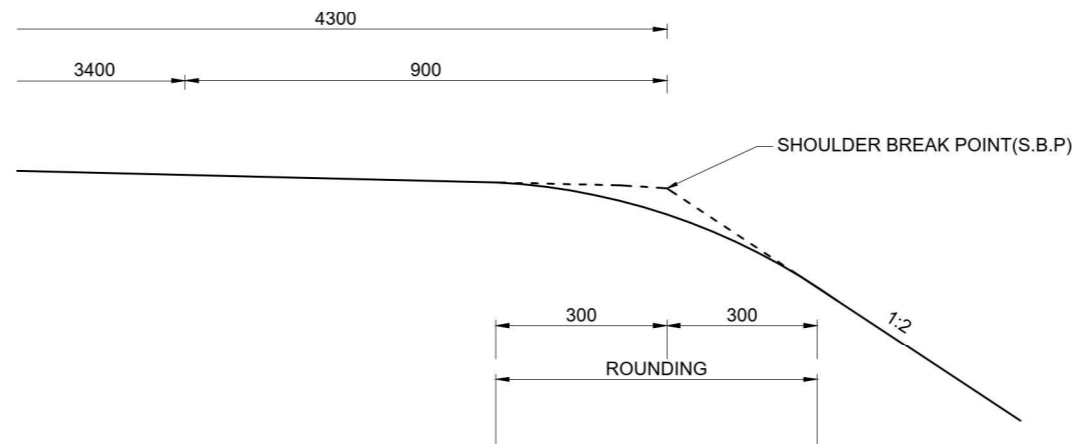

**DETAIL B**

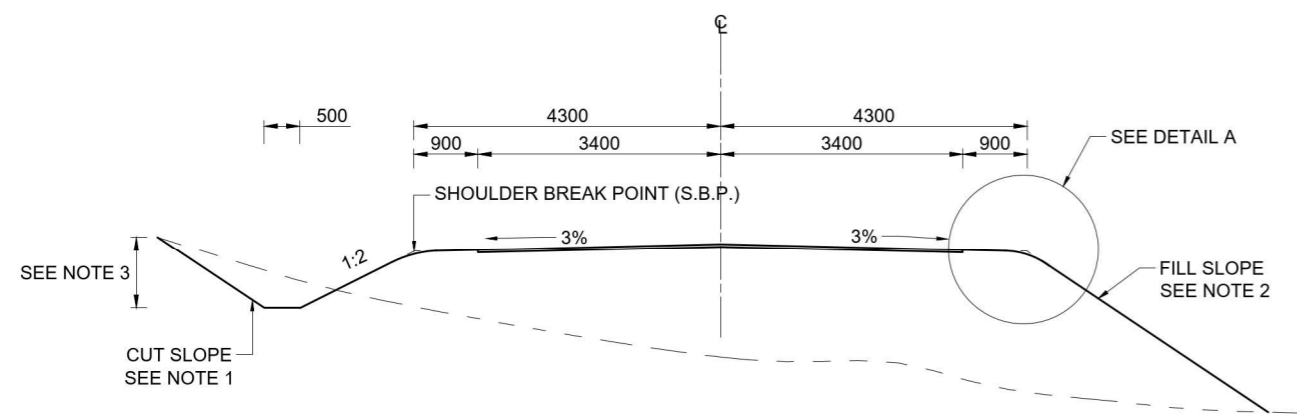

**CLASS 4 SURFACED CROSS SECTION**

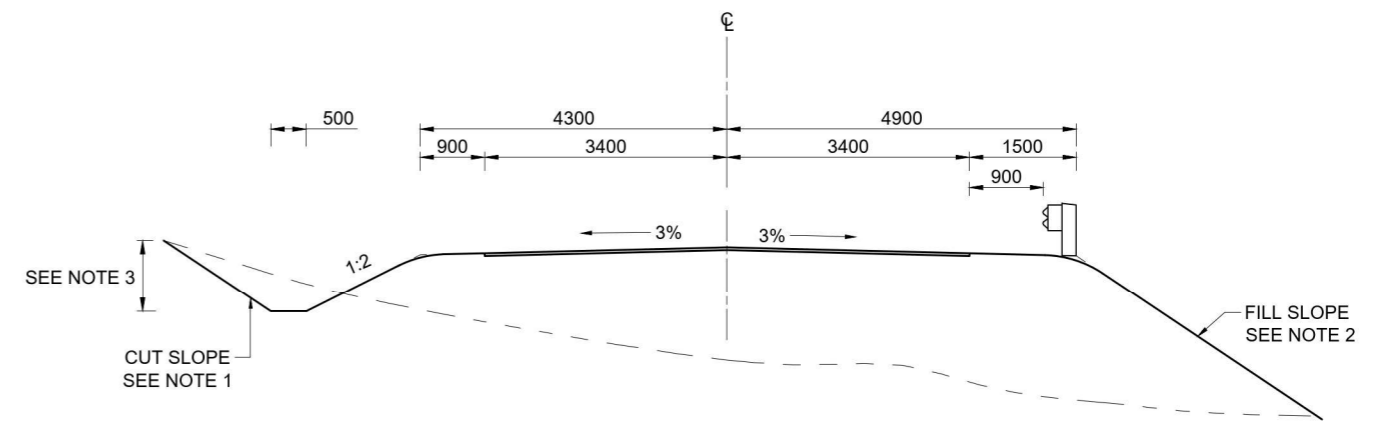

**CLASS 4 SURFACED CROSS SECTION (WITH GUARDRAIL)**

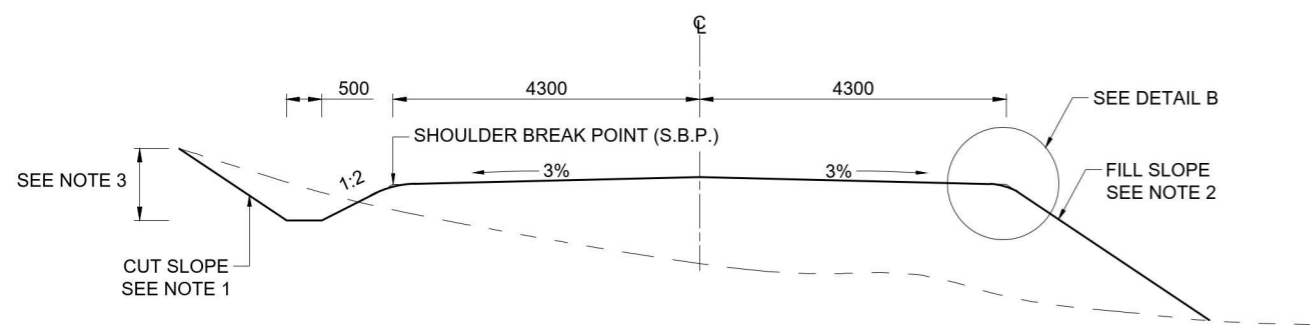

**CLASS 4 GRAVEL CROSS SECTION**

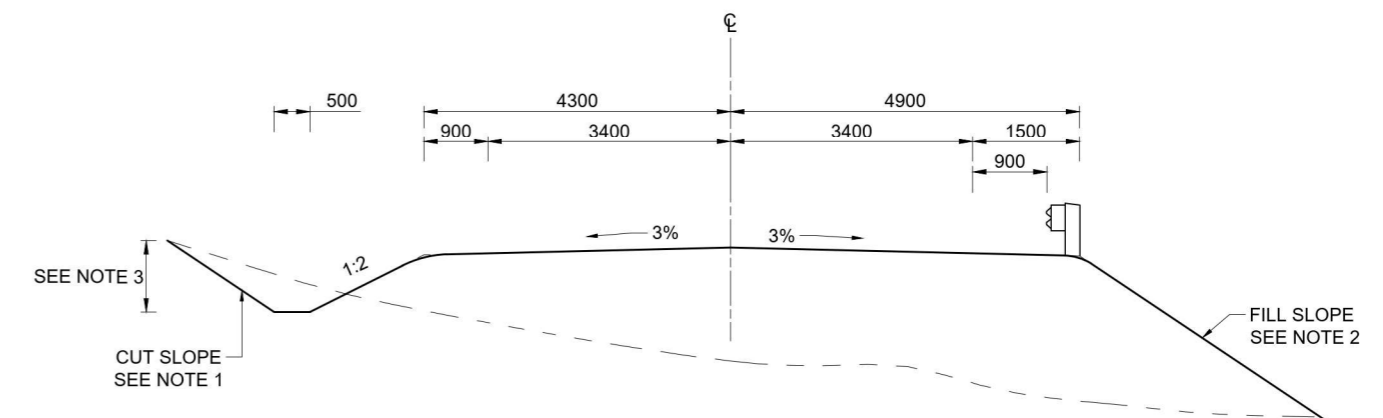

**CLASS 4 GRAVEL CROSS SECTION (WITH GUARDRAIL)**

No.	DATE	ADDITIONS AND AMENDMENTS
0	OCT - 2023	ORIGINAL VERSION

**STANDARD PLANS**

WESTERN CAPE GOVERNMENT  
 DEPARTMENT OF INFRASTRUCTURE  
 TRANSPORT INFRASTRUCTURE BRANCH

**CROSS SECTIONS**

**STANDARD LOW VOLUME CROSS SECTIONS**

SCALE : N.T.S.

A2 ORIGINAL

INDEX NO.  
**WCS/11/1/D2**

PLAN NO.  
**SHEET 2 OF 2**

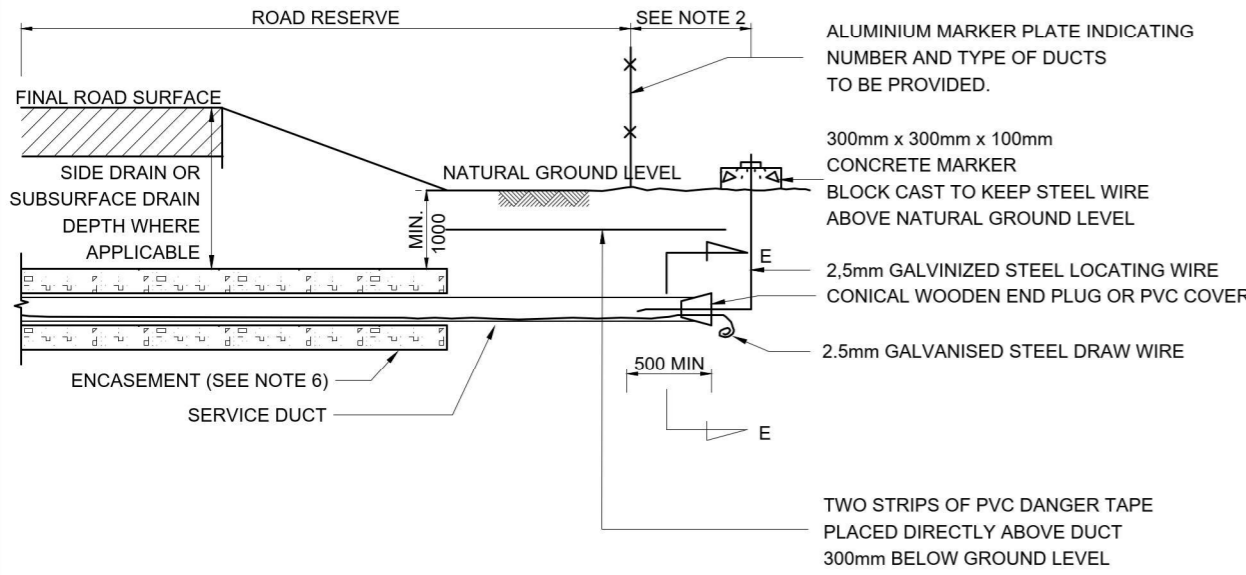

LONGITUDINAL SECTION OF SERVICE DUCT

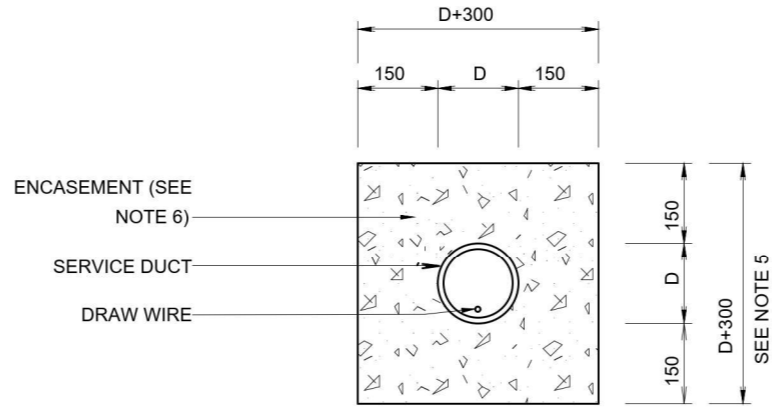

SECTION E-E

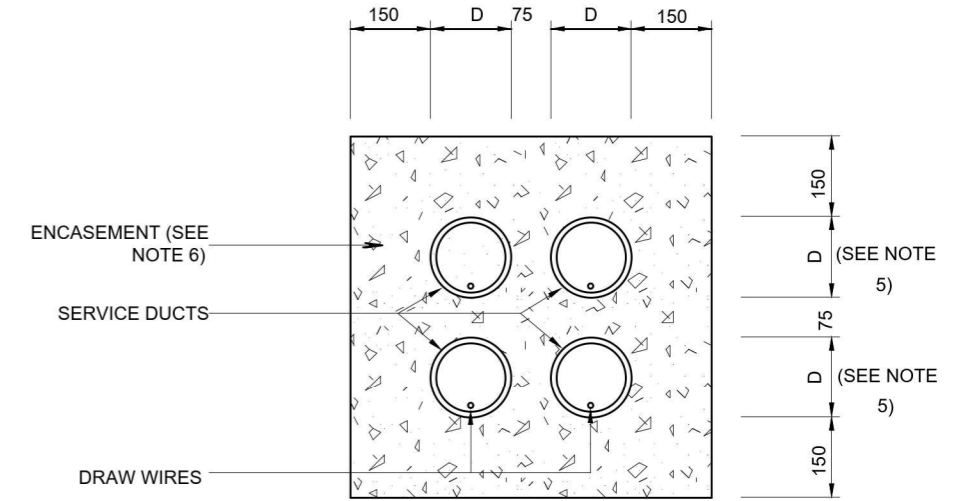

TYPICAL CROSS-SECTION OF MULTIPLE SERVICE DUCT

DUCTS WITHOUT INSTALLED SERVICE

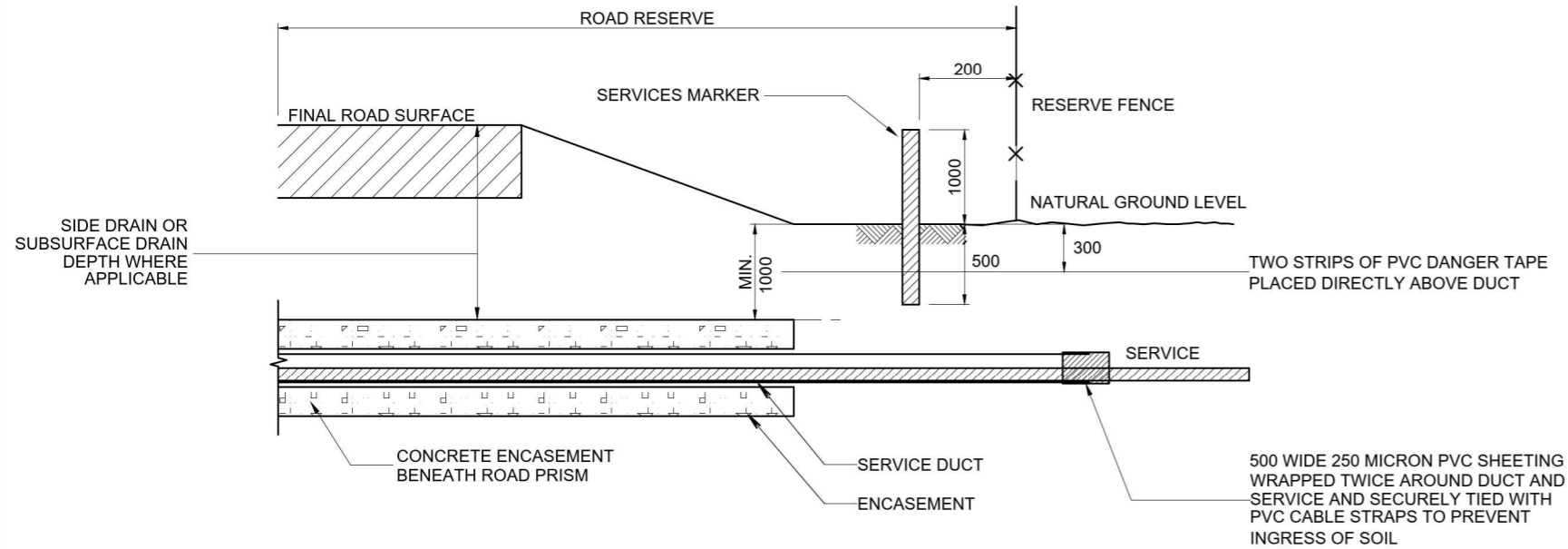

DUCT WITH INSTALLED SERVICE

NOTES :

1. P.V.C. SERVICE DUCT PIPES MUST COMPLY WITH SANS 791.
2. DUCTS MUST EXTEND BEYOND ROAD RESERVE BOUNDARIES, 1000mm
3. SERVICE DUCT TO BE LAID AT A MIN. SLOPE OF 1%.
4. FOR POSITIONS AND SIZES OF SERVICE DUCTS REFER TO LAYOUT PLANS.
5. D MAXIMUM = 200mm.
6. ENCASEMENT FOR DEPTH <2,0m : CONCRETE CLASS 20/20  
ENCASEMENT FOR DEPTH >2,0m : SOILCRETE (1:12 CEMENT:SOIL)

No.	DATE	ADDITIONS AND AMENDMENTS
0	OCT - 2023	ORIGINAL VERSION

STANDARD PLANS

WESTERN CAPE GOVERNMENT  
DEPARTMENT OF INFRASTRUCTURE  
TRANSPORT INFRASTRUCTURE BRANCH

SERVICE DUCTS

DETAILS OF SERVICES DUCTS FOR RURAL ROADS

SCALE : N.T.S.

A2 ORIGINAL

INDEX NO.  
**WCS/22/4/C1**

PLAN NO.  
**SHEET 1 OF 2**

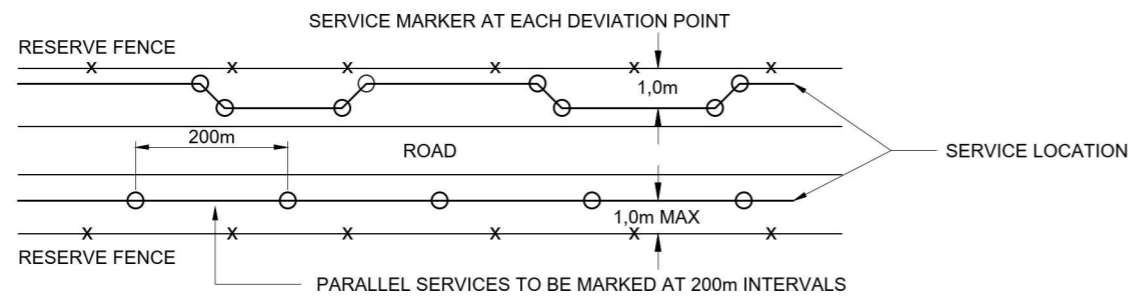

**MARKERS FOR PARALLEL UNDERGROUND SERVICES WITHIN ROAD RESERVE**

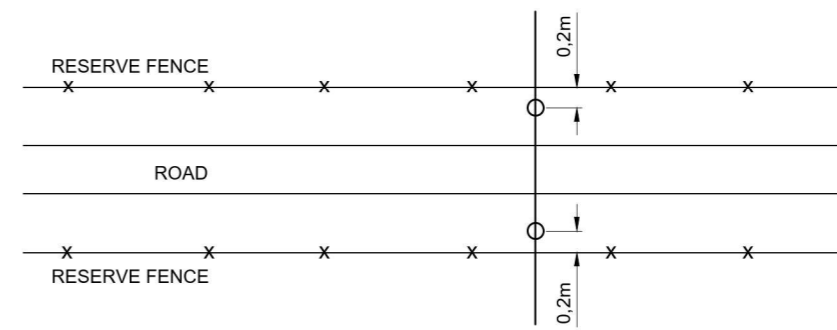

**MARKERS FOR UNDERGROUND SERVICES CROSSING ROAD RESERVE**

**POSITION OF SERVICES MARKERS**

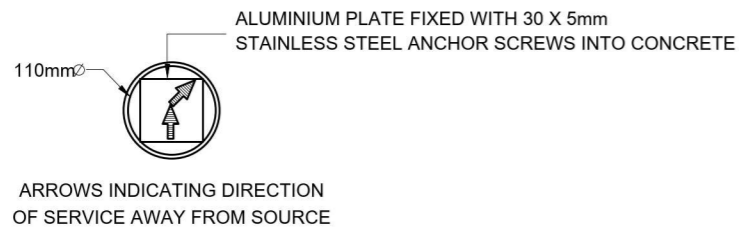

**DETAIL A**

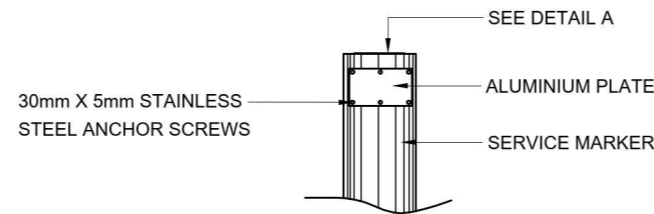

**DETAIL B**

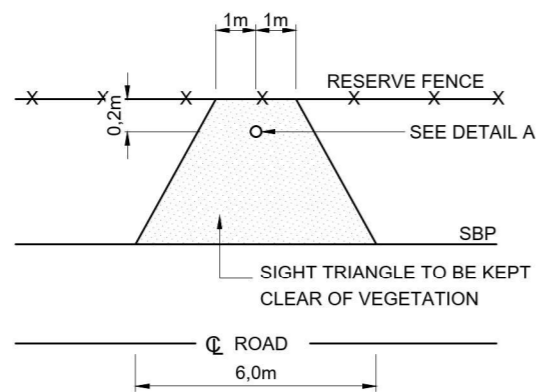

**PLACING OF SERVICES MARKER**

- NOTES:**
- SERVICES MARKERS TO BE uPVC CLASS 9 PIPES FILLED WITH CONCRETE CLASS 15/20 (1:3:6 MIX).
  - LENGTH OF PIPE : 1000mm ABOVE GROUND  
500mm BELOW GROUND
  - SERVICE MARKER TO BE PAINTED ACCORDING TO COLOUR CODE AS SHOWN, IF REQUIRED BY ROAD AUTHORITY.
  - EACH MARKER IS TO HAVE AN ALUMINIUM PLATE WITH THE DETAIL OF SERVICE AND OWNER PUNCHED ONTO IT (SEE DETAIL B).
  - THE TOP OF EACH MARKER IS ALSO TO HAVE AN ALUMINIUM PLATE WITH ARROWS PUNCHED ONTO IT INDICATING THE DIRECTION OF THE SERVICE AWAY FROM IT'S SOURCE. (SEE DETAIL A)
  - SERVICES MARKERS TO BE PROVIDED ON ALL ROADS.

SERVICE COLOUR CODES	
TYPE OF SERVICE	COLOUR
PETRONET PIPELINES	ORANGE
ESKOM CABLES	RED
TELKOM CABLES	YELLOW
ELECT.CABLES (PRIVATE)	RED
WATER PIPELINES	BLUE
TRANSTEL CABLES	BROWN

No.	DATE	ADDITIONS AND AMENDMENTS
0	OCT - 2023	ORIGINAL VERSION

**STANDARD PLANS**

**WESTERN CAPE GOVERNMENT**  
DEPARTMENT OF INFRASTRUCTURE  
TRANSPORT INFRASTRUCTURE BRANCH

**SERVICE DUCTS**

**DETAILS OF SERVICE DUCT MARKERS**

SCALE : N.T.S.

A2 ORIGINAL

INDEX NO.  
**WCS/22/4/C2**

PLAN NO.  
**SHEET 2 OF 2**

## Appendix I – Sight Distance Assessment



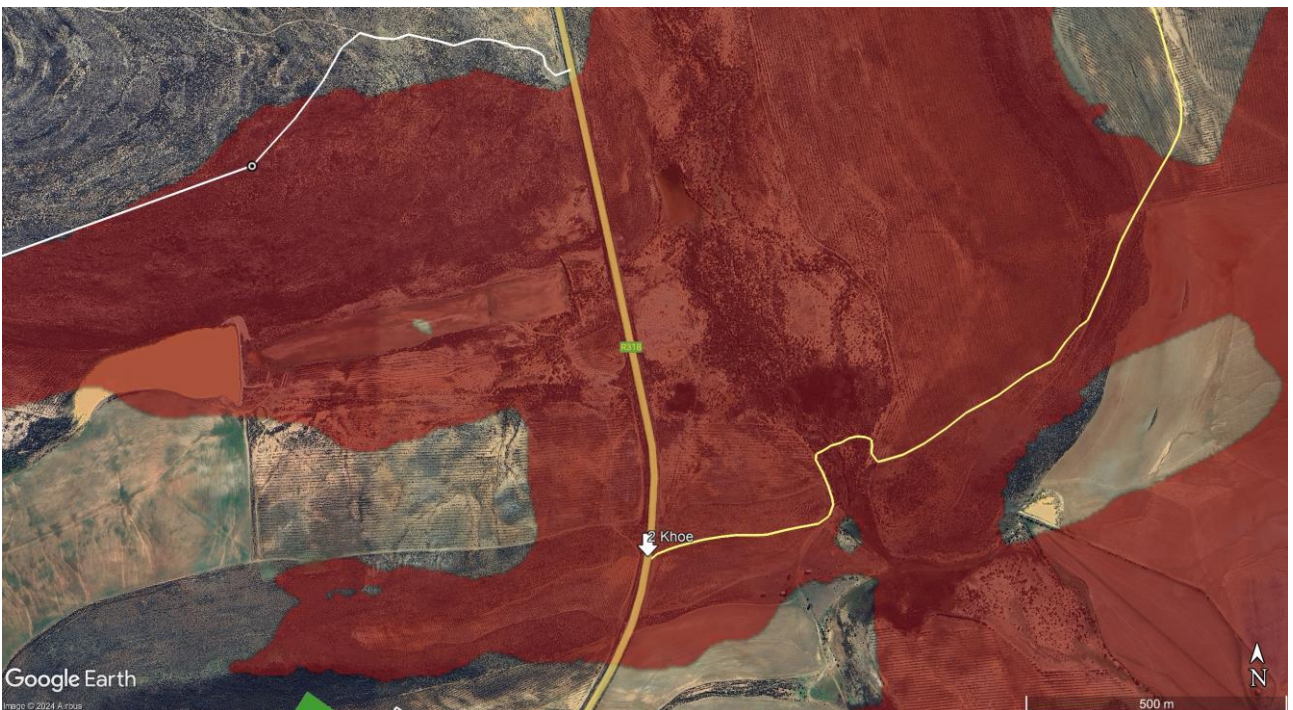
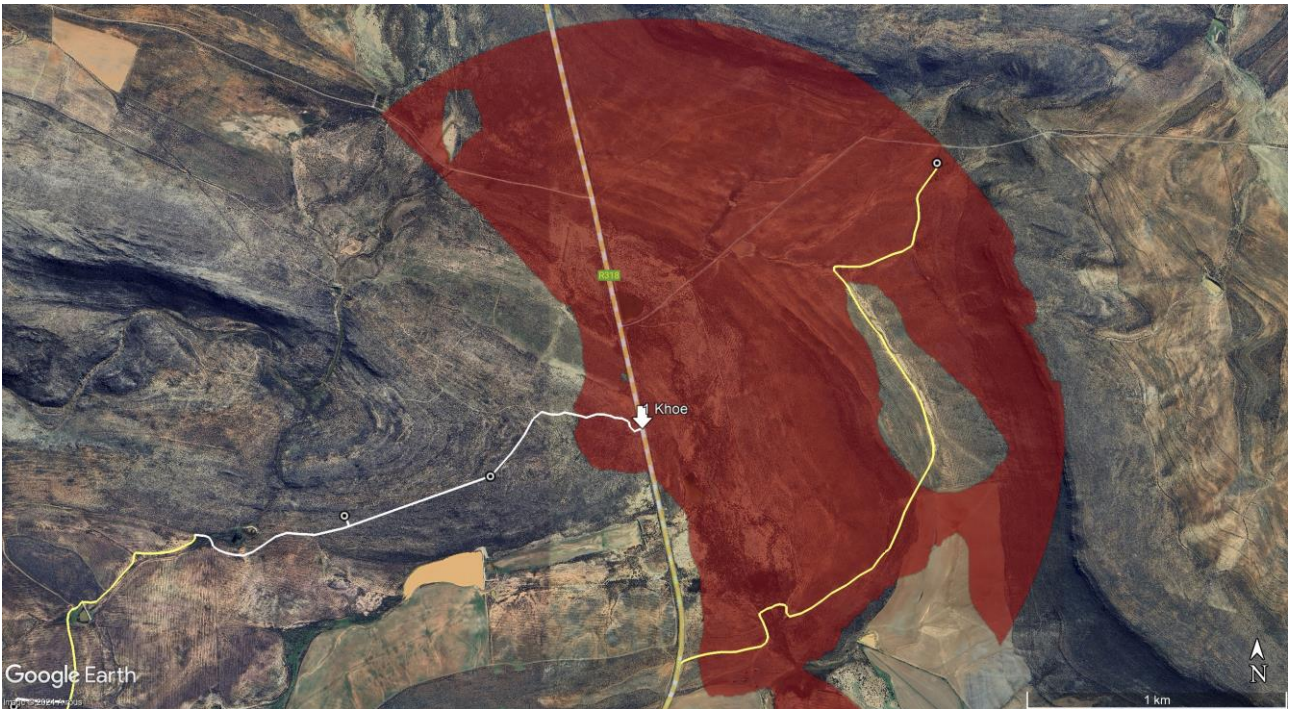



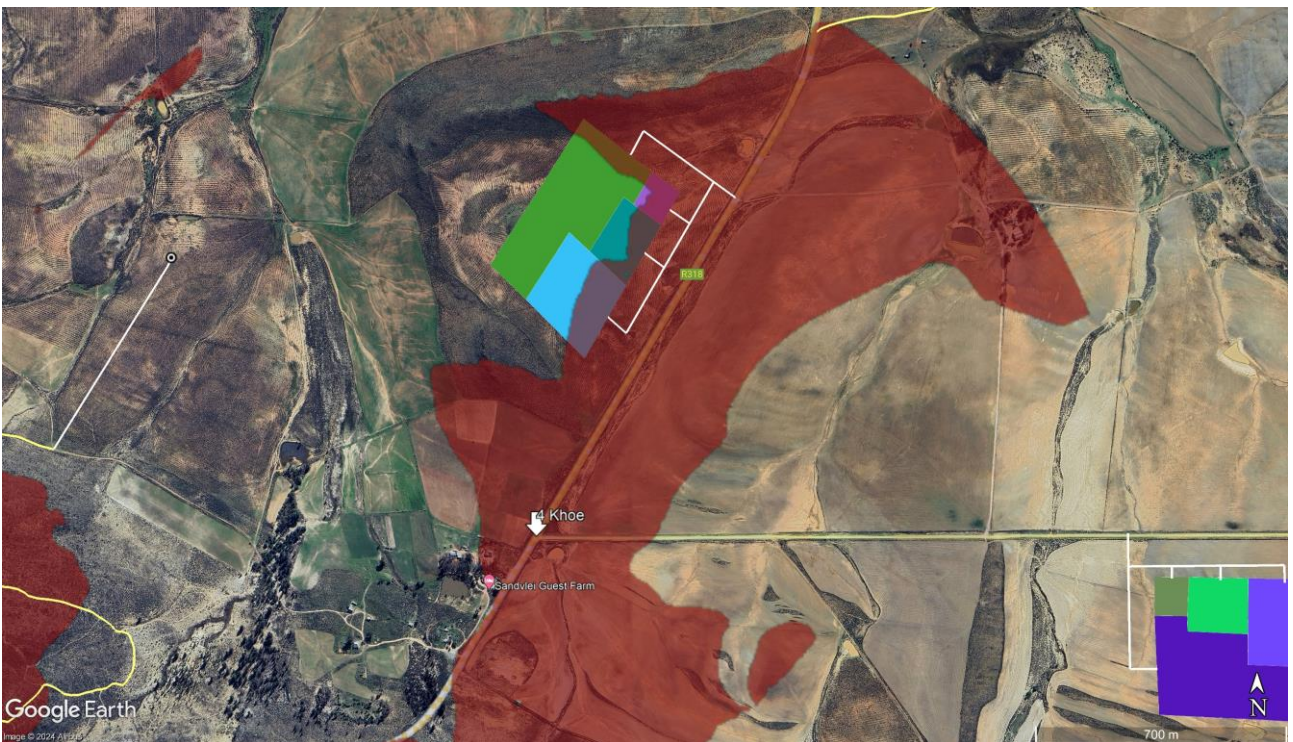
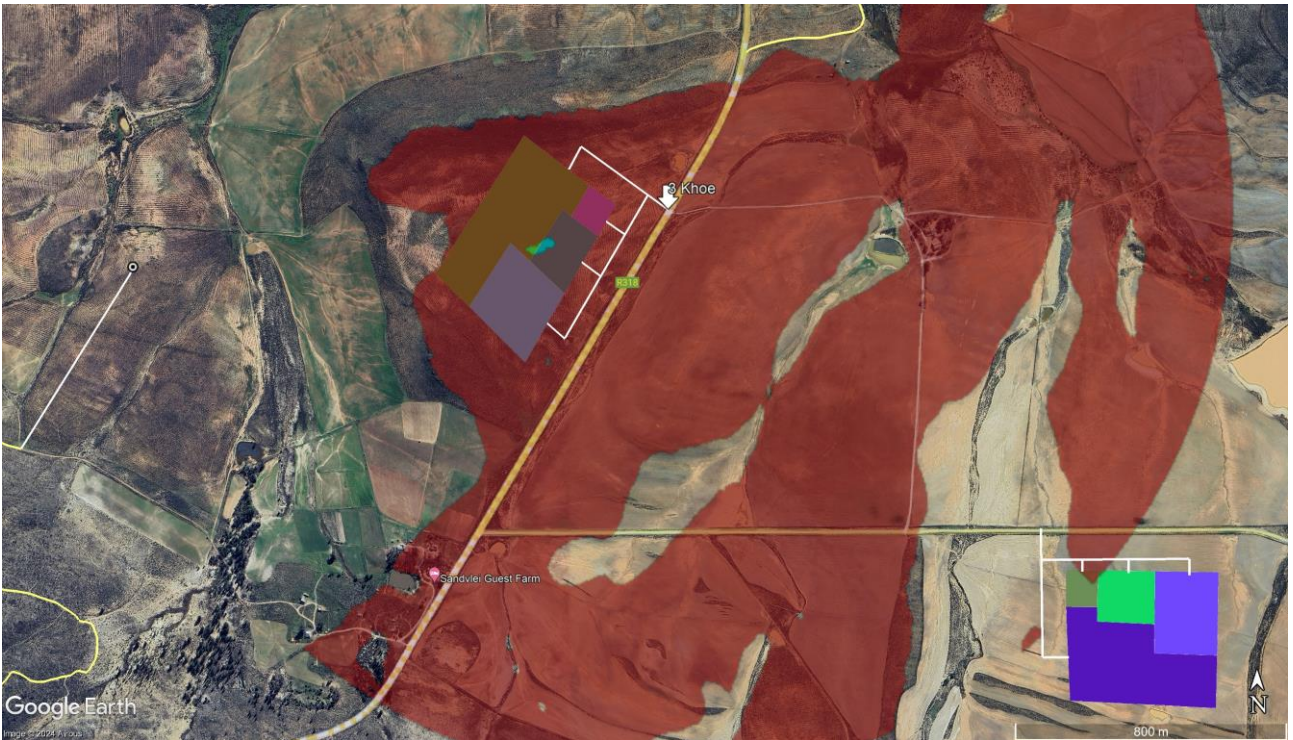







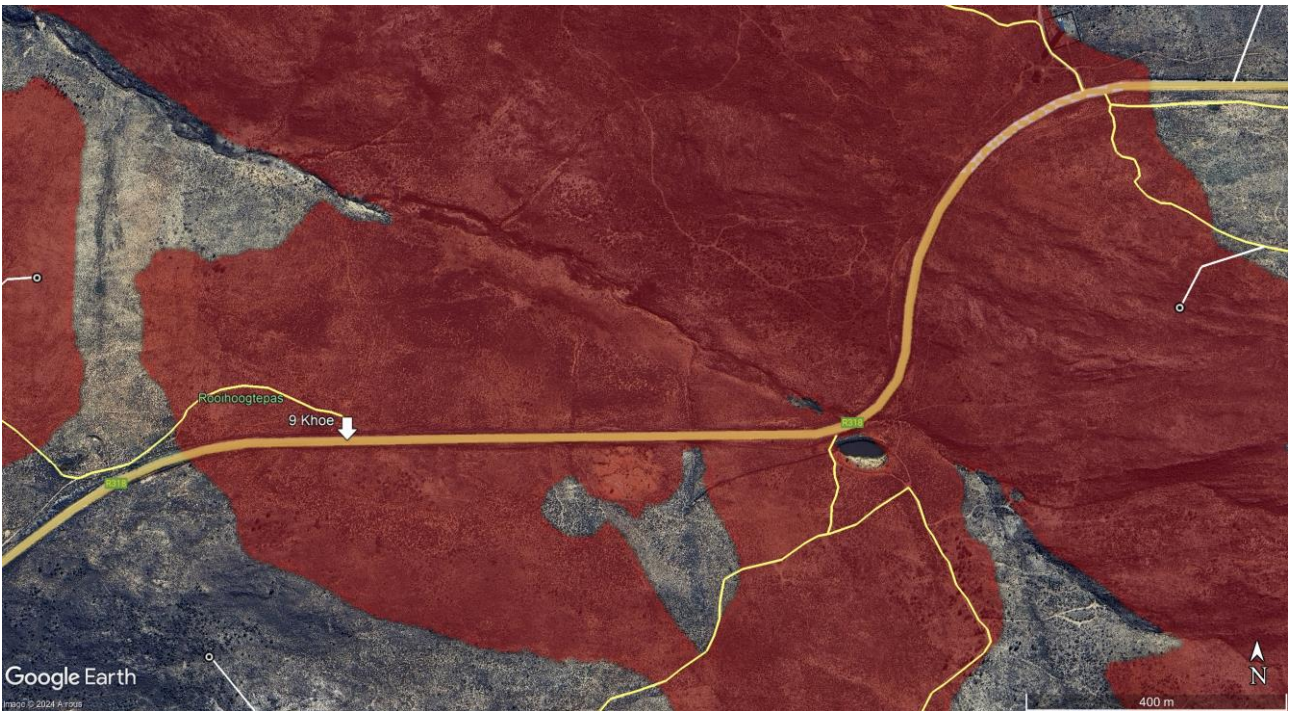



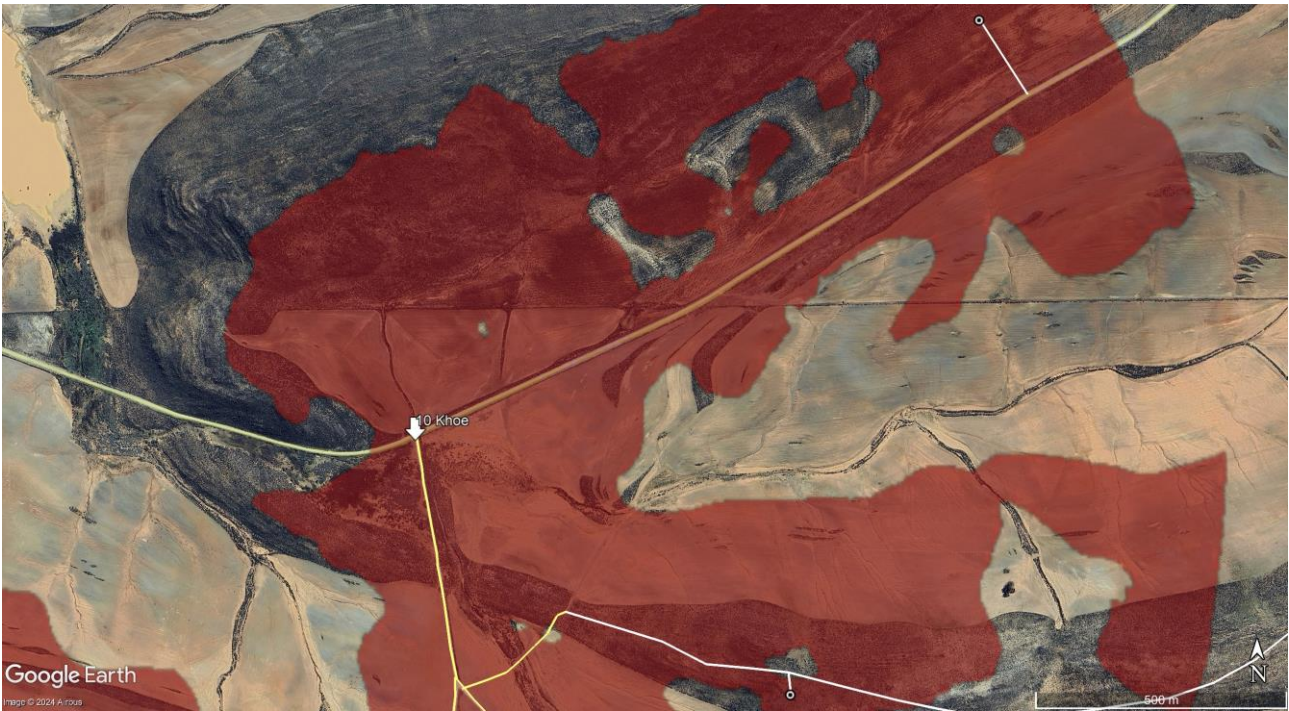



## Appendix J – Traffic Flow Diagrams

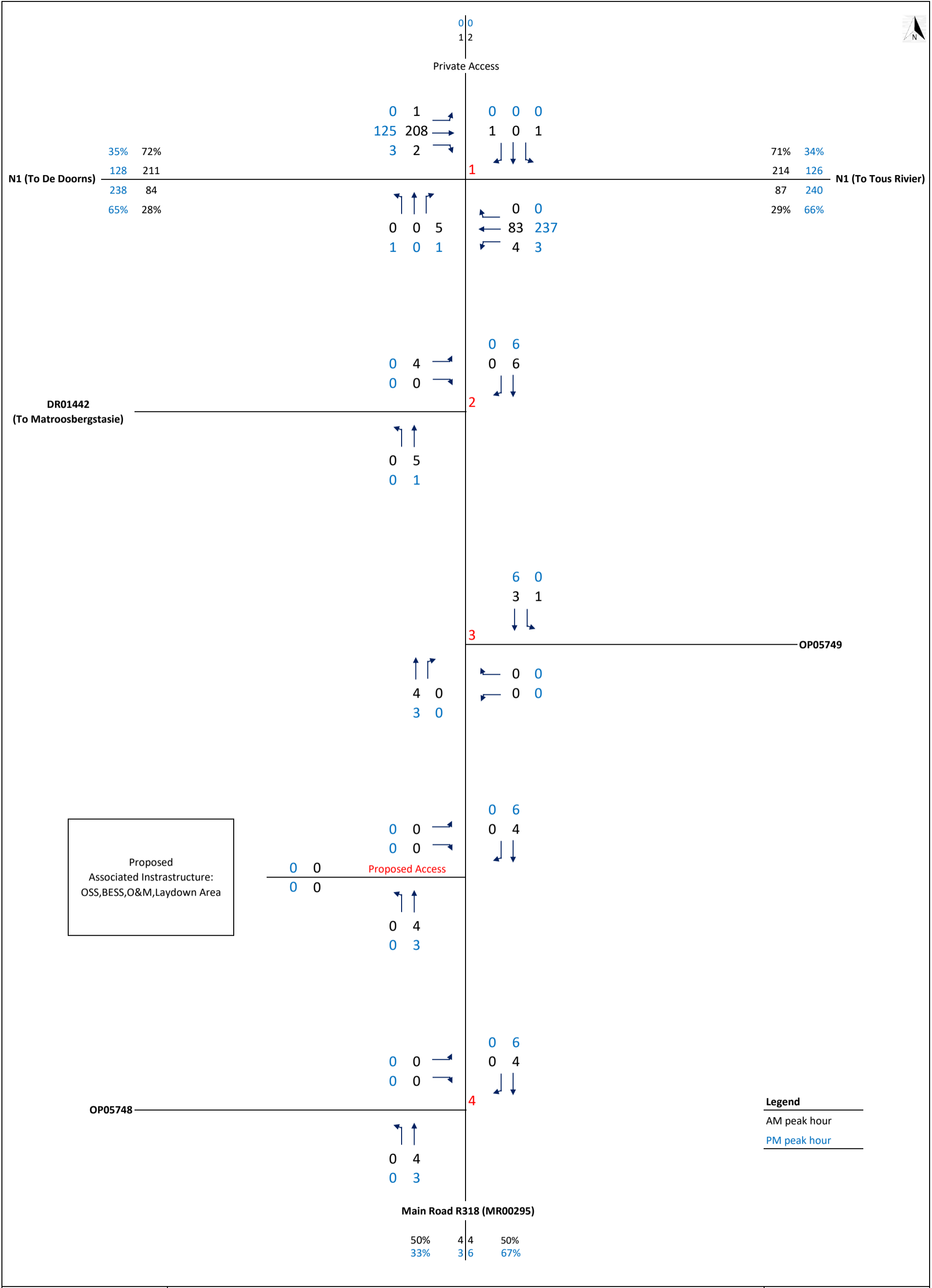

Proposed  
Associated Infrastructure:  
OSS, BESS, O&M, Laydown Area

**Legend**  
AM peak hour  
PM peak hour



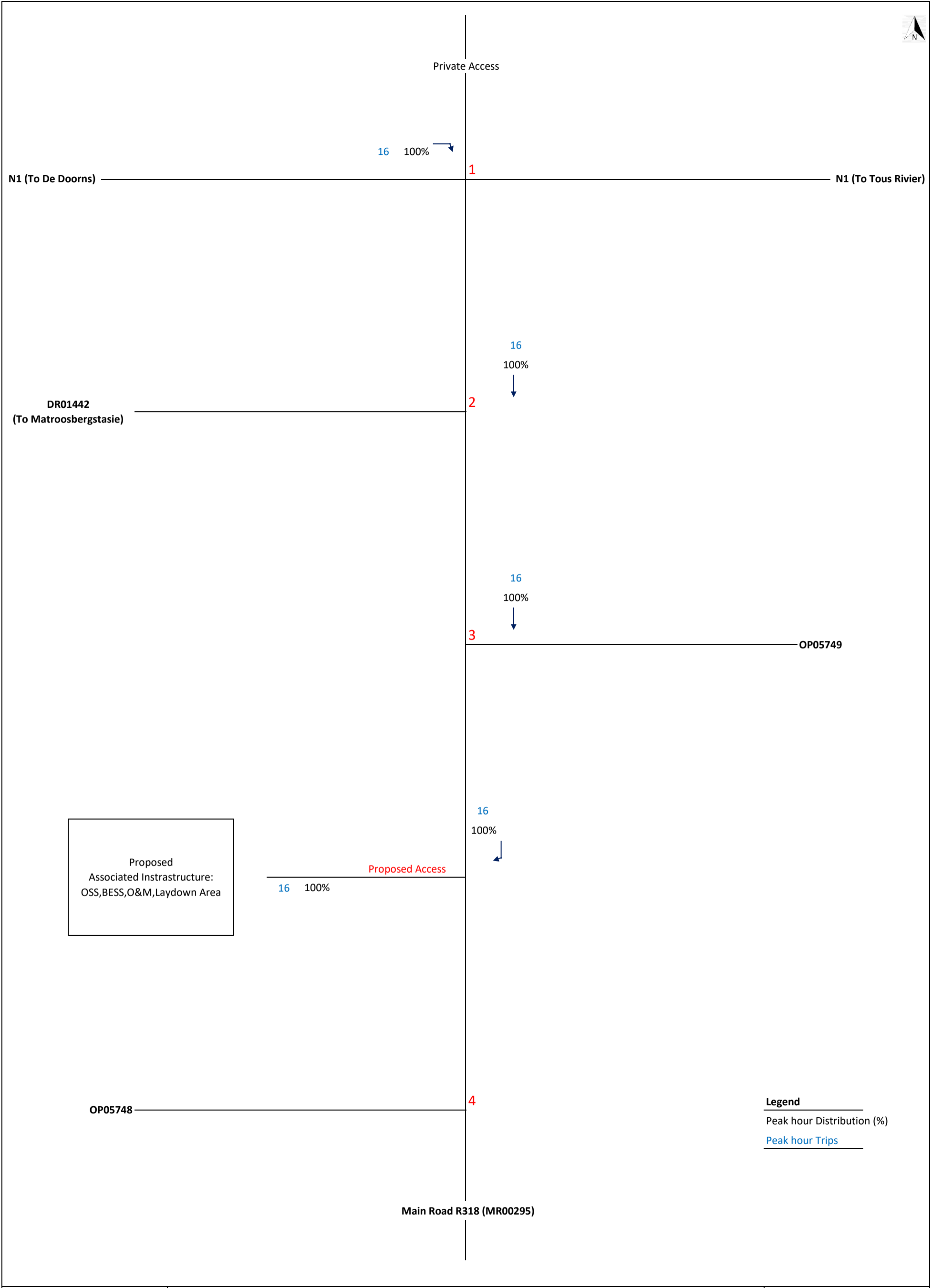

**Hugo WEF**  
**Construction Phase Distribution (%)**  
**Abnormal Load**

**Figure J2**

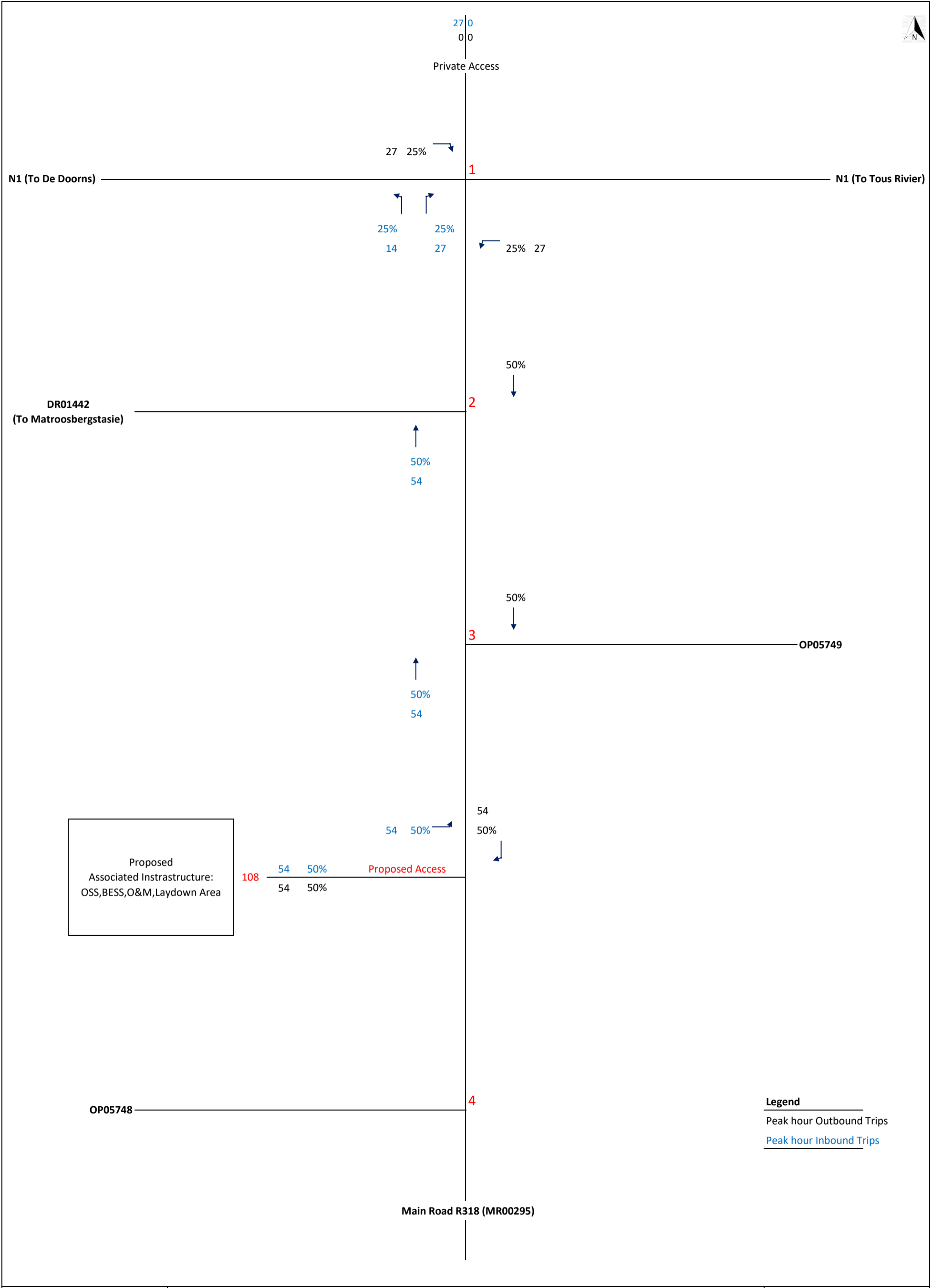



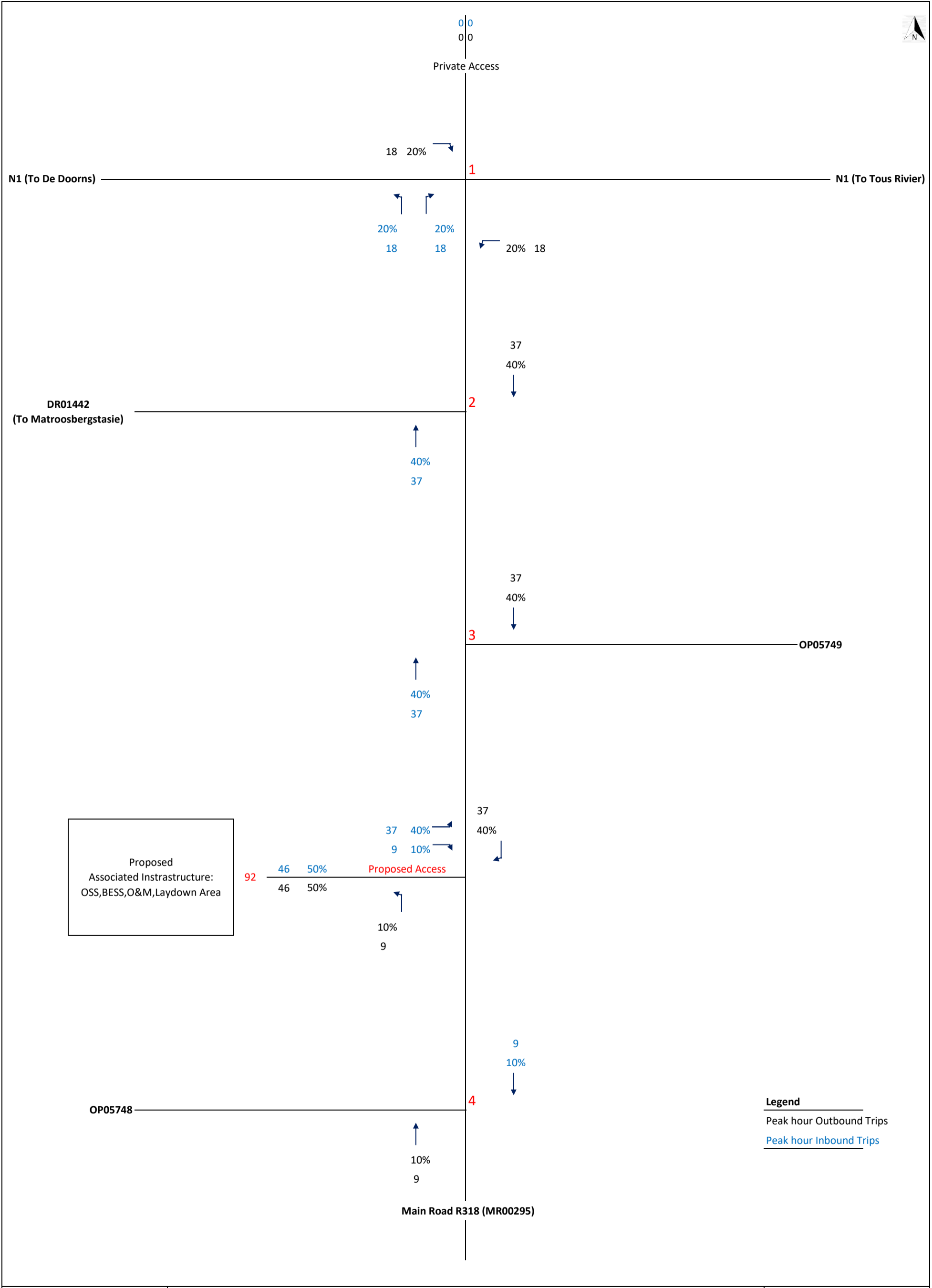

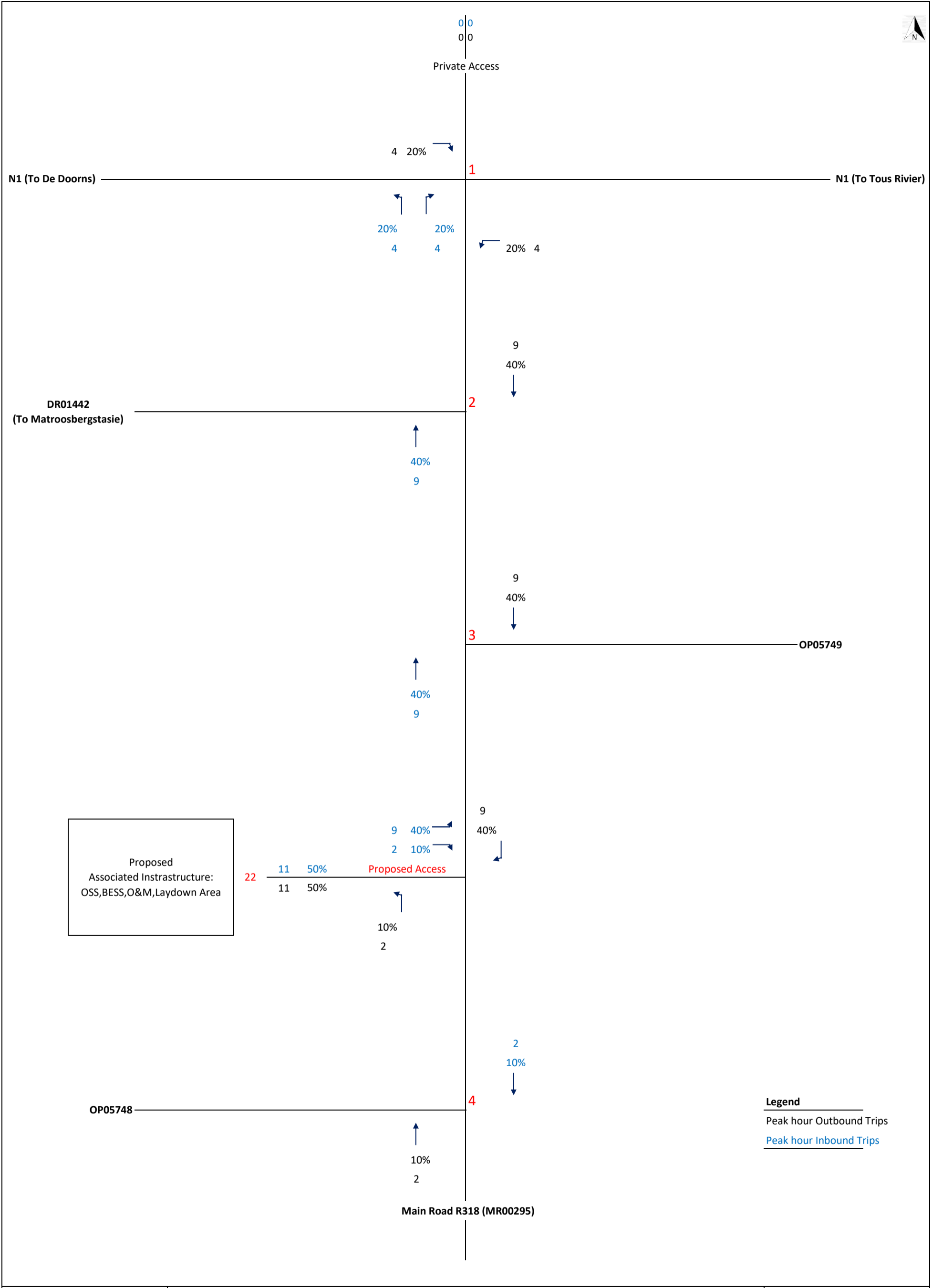

**Hugo WEF**  
 Operational Phase Distribution (%)  
 Labour

Figure J5

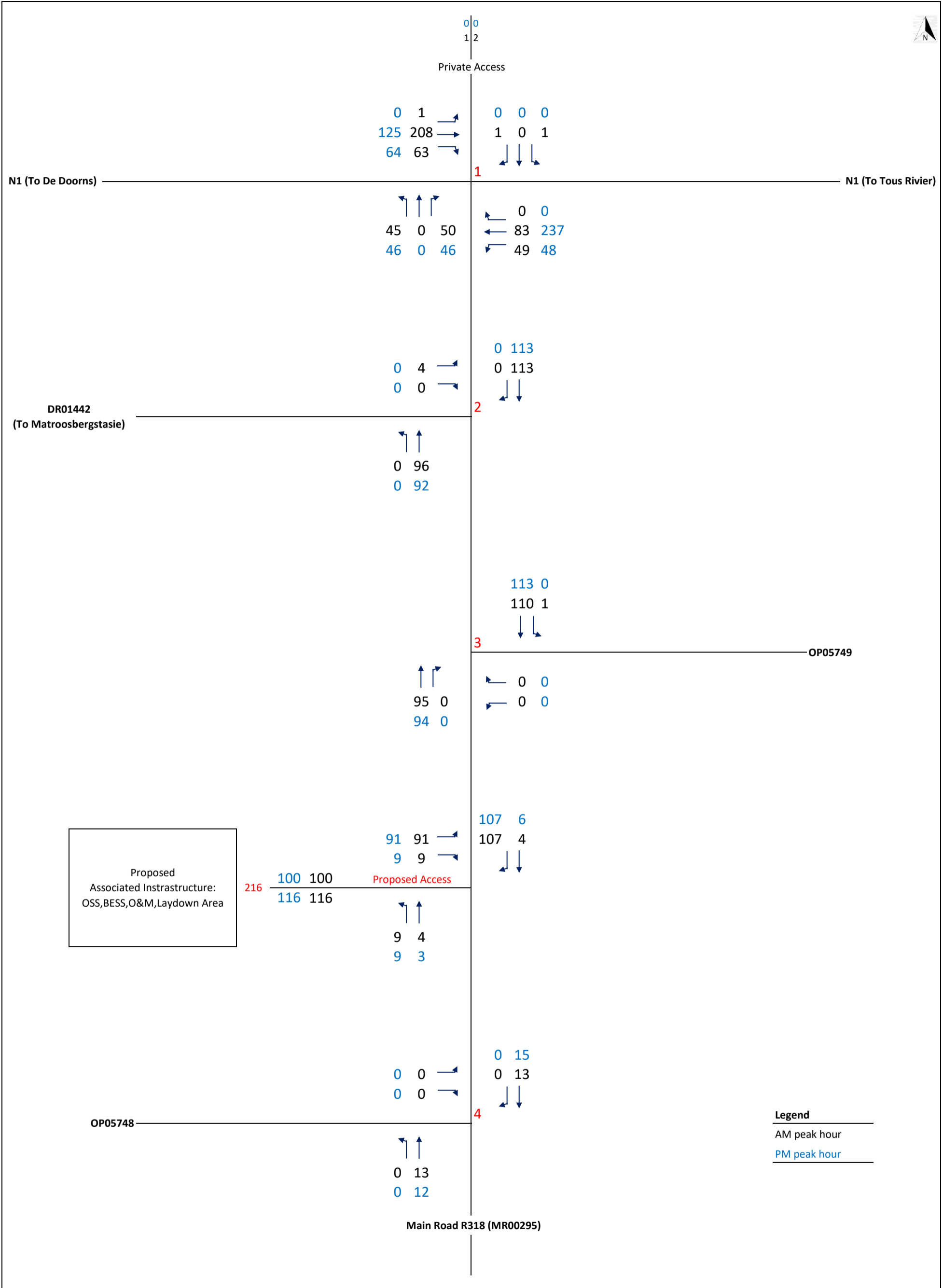

**Hugo WEF**  
 2024 Base Year Traffic + Construction Phase Traffic  
 Total AM Peak Hour & PM Peak Hour

Figure J6

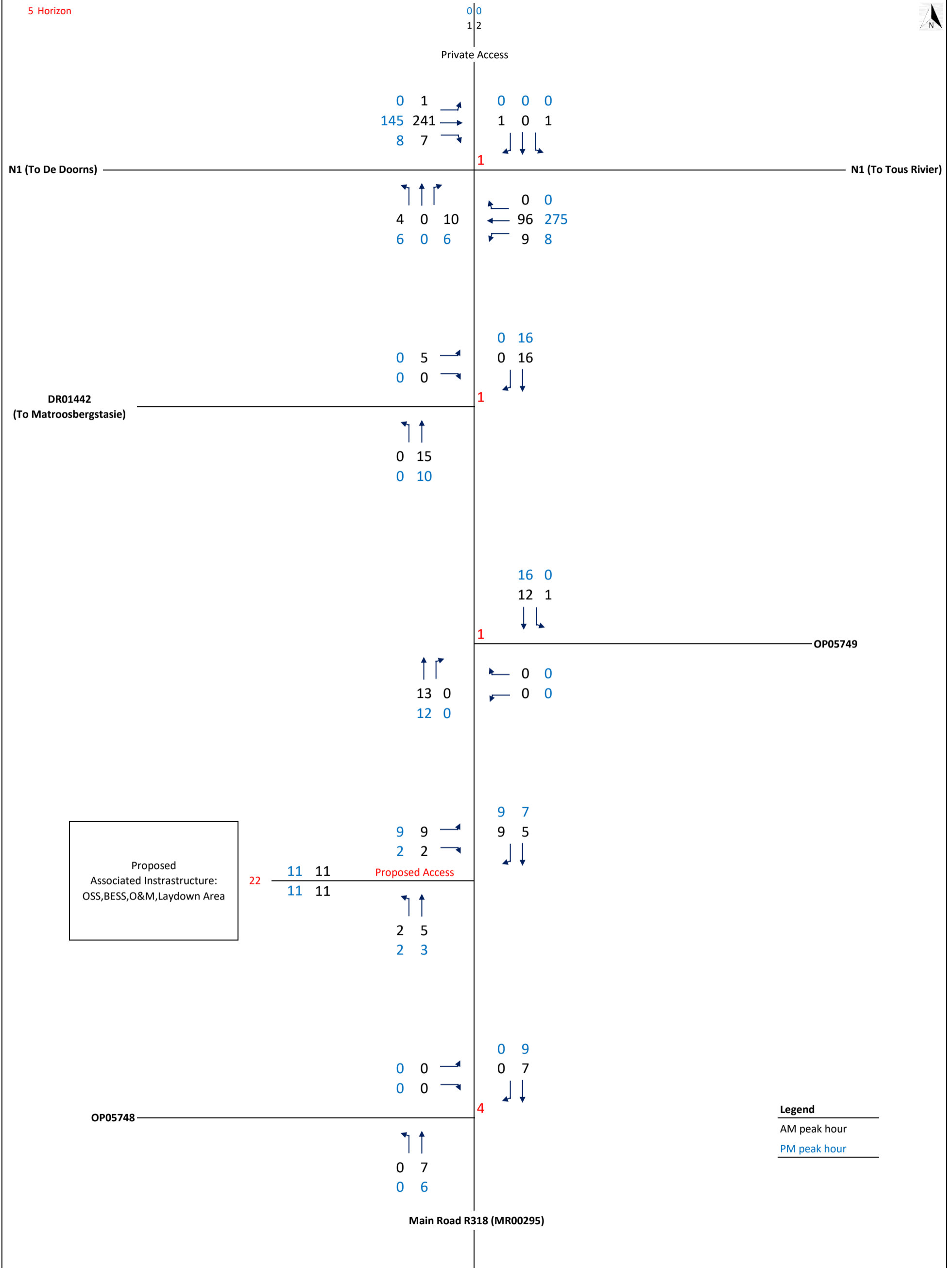

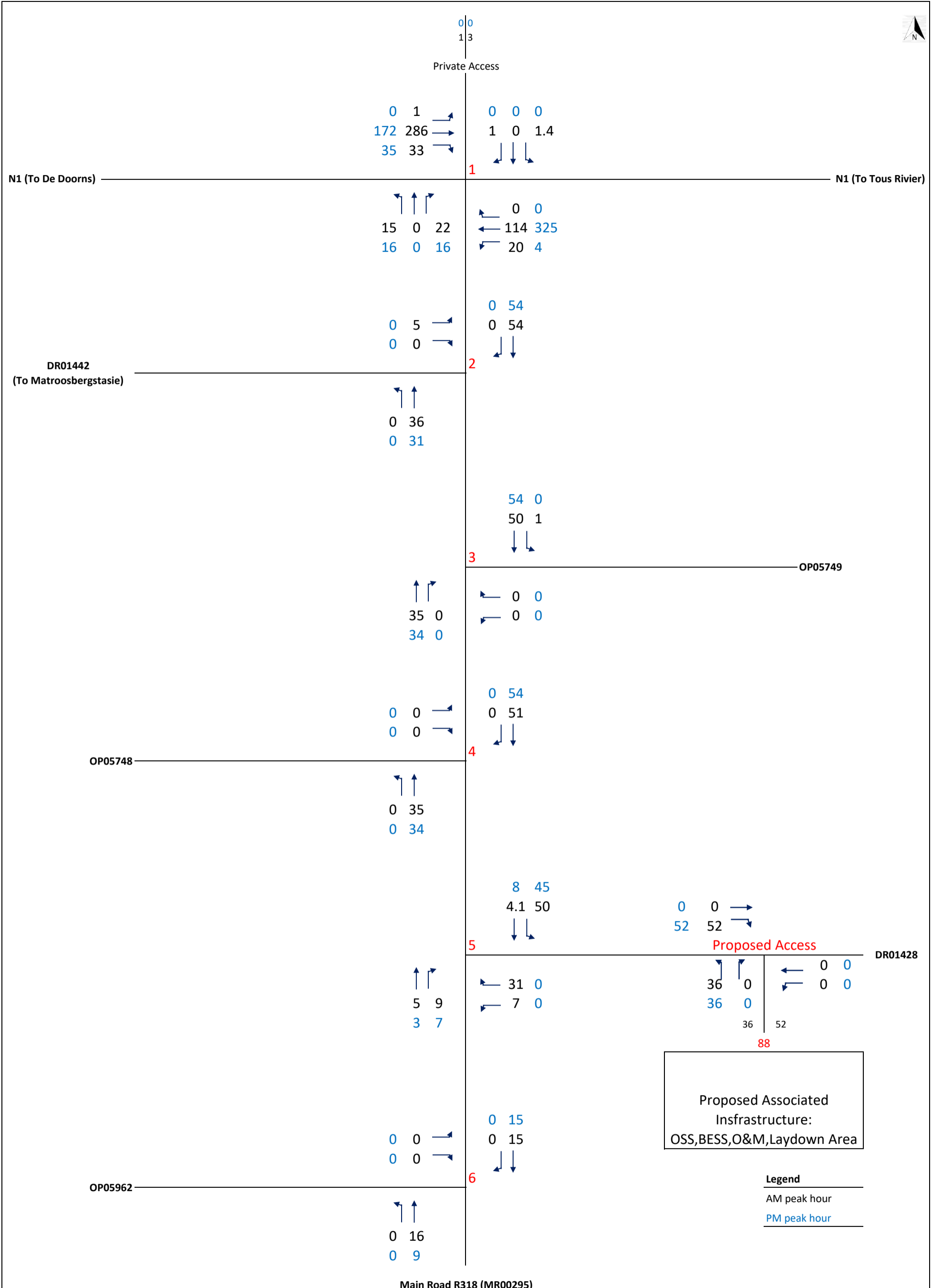

**Khoe WEF**  
2046 Background Traffic+ Decommission Phase Traffic  
Total AM Peak Hour & PM Peak Hour

Figure J8



## Appendix K – Impact Assessment Methodology

## 1 SPECIALIST REPORTING REQUIREMENTS

**The Specialist EIA Report** must comply with the requirement of GN 43110 of NEMA: Environmental Themes Reporting Criteria and the Relevant Protocols Gazetted, unless no protocol is prescribed, then the Appendix 6 of the EIA Regulations, 2014 (as amended), must be followed, as well as other relevant protocols, guidelines, policies and/or plans.

The specialist report will include the specialist impact assessment of the proposed developments. The terms of reference for specialist studies includes (but is not limited to):

- Site Visit
- Desktop Screening
- Mapping
- Sensitivity Analysis and/or modelling
- Submission of Shapefiles
- Defining the legal, planning and policy context,
- Description of the Baseline Environment
- Determination of potential impacts (direct, indirect, cumulative)
- Determination of residual risks
- Reporting
- Recommendation and input into project design
- Management Plan and/or Monitoring Programme for inclusion in the EMPr
- Sensitivity Verification Reporting in terms of GN 320 of 20 March 2020 and/or a Compliance Statement in terms of GN 320 / GN 1150 of 20 March 2020

## 2 IMPACT ASSESSMENT METHODOLOGY

The purpose of the assessment of impacts in an EIA is to evaluate the likely extent and overall significance that a potential impact may have on an identified receptor or resource. Another important aspect of the assessment of impacts is to quantify those impacts that are not scientific-based or evidence-based and include the opinions of others (i.e., the involvement and comment from I&APs).

A successful assessment of the potential significance of impacts will include the description and development of measures that will be taken to avoid, minimise or compensate for any adverse environmental impacts, to enhance positive impacts, and to report the significance of residual impacts that occur following mitigation.

A 7-step approach for the determination of significance of potential impacts was developed by ERM to align with the requirements of Appendix 3 of the EIA Regulations, 2014 (as amended). The approach is both objective and scientific based to allow appointed specialists and EAPs to retain independence throughout the assessment process.

ERM has adapted this 7-step approach from standard ranking metrics such as the Hacking Method, Crawford Method etc. The ERM 7-step approach complies with the method provided in the EIA guideline document (GN 654 of 2010) and considers international EIA Regulatory reporting standards such as the newly amended European Environmental Impact Assessment (EIA) Directive (2014/52/EU).

The 7-Step approach for determining the significance of impacts pre, and post mitigation, is described below:

- **Step 1:** Predict potential impacts by means of an appraisal of:
  - Site Surveys,
  - Project-related components and infrastructure,
  - Activities related with the project life-cycle,

- The nature and profile of the receiving environment and potential sensitive environmental features and attributes,
  - Input received during public participation from all stakeholders, and
  - The relevant legal framework applicable to the proposed development
- **Step 2:** Determination of whether the potential impacts identified in **Step 1** will be *direct* (caused by construction, operation, decommissioning or maintenance activities on the proposed development site or immediate surroundings of the site), *indirect* (not immediately observable or do not occur on the proposed development site or immediate surroundings of the site), *residual* (those impacts which remain after post mitigation) and *cumulative* (the combined impact of the project when considered in conjunction with similar projects in proximity).
  - **Step 3:** Description and determination of the significance of the predicted impacts in terms of the criteria below to ensure a consistent and systematic basis for the decision-making process. Significance is numerically quantified on the basis score of the following impact parameters:
    1. **Extent (E)** of the impact: The geographical extent of the impact on a given environmental receptor.
    2. **Duration (D)** of the impact: The length of permanence of the impact on the environmental receptor.
    3. **Reversibility (R) of the impact:** The ability of the environmental receptor to rehabilitate or restore after the activity has caused environmental change
    4. **Magnitude (M)** of the impact: The degree of alteration of the affected environmental receptor.
    5. **Probability (P)** of the impact: The likelihood of the impact actually occurring.

A widely accepted numerical quantification of significance is the formula:

$$S=(E+D+R+M)*P$$

Where: *Significance=(Extent+Duration+Reversibility+Magnitude) \* Probability*

The following has also been considered when determining the significance of a potential impact.

6. **Nature (N)** of the impact: A description of what causes the effect, what will be affected, and how it will be affected.
7. **Status (S)** of the impact: described as either positive, negative or neutral
8. **Cumulative impacts.**
9. Inclusion of **Public comment.**

The significance of environmental impacts is determined and ranked by considering the criteria presented in **Table 1** below. All criteria are rank according to 'Very Low', 'Low', 'Moderate', 'High' and 'Very High' and are assigned scores of 1 to 5 respectively.

**Table 1: Defining the significant in terms of the impact criteria.**

Impact Criteria	Definition	Score	Criteria Description
<b>Extent (E)</b>	Site	1	Impact is on the site only
	Local	2	Impact is localized inside the activity area
	Regional	3	Impact is localized outside the activity area
	National	4	Widespread impact beyond site boundary. May be defined in various ways, e.g. cadastral, catchment, topographic

Impact Criteria	Definition	Score	Criteria Description
	International	5	Impact widespread far beyond site boundary. Nationally or beyond
<b>Duration (D)</b>	Immediate	1	On impact only
	Short term	2	Quickly reversible, less than project life. Usually up to 5 years.
	Medium term	3	Reversible over time. Usually between 5 and 15 years.
	Long term	4	Longer than 10 years. Usually for the project life.
	Permanent	5	Indefinite
<b>Magnitude (M)</b>	Very Low	1	No impact on processes
	Low	2	Qualitative: Minor deterioration, nuisance or irritation, minor change in species/habitat/diversity or resource, no or very little quality deterioration. Quantitative: No measurable change; Recommended level will never be exceeded.
	Moderate	3	Qualitative: Moderate deterioration, discomfort, Partial loss of habitat /biodiversity /resource or slight or alteration. Quantitative: Measurable deterioration; Recommended level will occasionally be exceeded.
	High	4	Qualitative: Substantial deterioration death, illness or injury, loss of habitat /diversity or resource, severe alteration or disturbance of important processes. Quantitative: Measurable deterioration; Recommended level will often be exceeded(e.g. pollution)
	Very High	5	Permanent cessation of processes
<b>Reversibility (R)</b>	Reversible	1	Recovery which does not require rehabilitation and/or mitigation.
	Recoverable	3	Recovery which does require rehabilitation and/or mitigation.
	Irreversible	5	Not possible, despite action. The impact will still persist, and no mitigation will remedy or reverse the impact.
<b>Probability (P)</b>	Improbable	1	Not likely at all. No known risk or vulnerability to natural or induced hazards
	Low Probability	2	Unlikely; low likelihood; Seldom; low risk or vulnerability to natural or induced hazards
	Probable	3	Possible, distinct possibility, frequent; medium risk or vulnerability to natural or induced hazards.
	Highly Probable	4	Highly likely that there will be a continuous impact. High risk or vulnerability to natural or induced hazards
	Definite	5	Definite, regardless of prevention measures.

The *significance* (s) of potential impacts identified according to the criteria above has been colour coded for the purpose of comparison. This colour coding will be used in impact tables.

Significance is deemed Negative (-)			Significance is deemed Positive (+)		
0 - 30	31 - 60	61 - 100	0 - 30	31 - 60	61 - 100
Low	Moderate	High	Low	Moderate	High

- **Step 4:** Determination of practical and reasonable mitigation measures based on specialists' inputs and field observations following the mitigation hierarchy (avoid, minimise, manage, mitigate, or rehabilitate).
- **Step 5:** Evaluation of predicted residual impacts after implementation of mitigation measures.
- **Step 6:** Determination of the significance of the impact taking into consideration the predicted residual impacts after implementation of mitigation measures.
- **Step 7:** Based on an acceptable significance of the impact, determination of the need and desirability of the proposed development and an opinion as to whether the development should proceed or not.



## Appendix L – Specialist Declaration Form\_August 2023



# forestry, fisheries & the environment

Department:  
Forestry, Fisheries and the Environment  
REPUBLIC OF SOUTH AFRICA

Private Bag X447, Pretoria, 0001, Environment House, 473 Steve Biko Road, Pretoria, 0002 Tel: +27 12 399 9000, Fax: +27 86 625 1042

## **SPECIALIST DECLARATION FORM – AUGUST 2023**

Specialist Declaration form for assessments undertaken for application for authorisation in terms of the National Environmental Management Act, Act No. 107 of 1998, as amended and the Environmental Impact Assessment (EIA) Regulations, 2014, as amended (the Regulations)

### **REPORT TITLE**

**Traffic Impact Assessment: Proposed Khoe Wind Energy Facility (WEF)**

### **Kindly note the following:**

1. This form must always be used for assessment that are in support of applications that must be subjected to Basic Assessment or Scoping & Environmental Impact Reporting, where this Department is the Competent Authority.
2. This form is current as of August 2023. It is the responsibility of the Applicant / Environmental Assessment Practitioner (EAP) to ascertain whether subsequent versions of the form have been published or produced by the Competent Authority. The latest available Departmental templates are available at <https://www.dffe.gov.za/documents/forms>.
3. An electronic copy of the signed declaration form must be appended to all Draft and Final Reports submitted to the department for consideration.
4. The specialist must be aware of and comply with 'the Procedures for the assessment and minimum criteria for reporting on identified environmental themes in terms of sections 24(5)(a) and (h) and 44 of the act, when applying for environmental authorisation - GN 320/2020', where applicable.

### **1. SPECIALIST INFORMATION**

Title of Specialist Assessment	Traffic Impact Assessment: Proposed Khoe Wind Energy Facility (WEF)
Specialist Company Name	SMEC South Africa (Pty) Ltd
Specialist Name	Victor de ABREU
Specialist Identity Number	6310295131087
Specialist Qualifications:	Master of Science in Engineering
Professional affiliation/registration:	Professional Engineer (ECSA) – Membership No. 950108, 16/03/1995
Physical address:	267 Kent Avenue, Ferndale, Johannesburg, 2194, South Africa
Postal address:	PO Box 72927
Postal address	Pinegowrie, 2023
Telephone	+27 11 369 0600
Cell phone	+27 82 416 9393
E-mail	Victor.deAbreu@smec.com

## SPECIALIST DECLARATION FORM – AUGUST 2023

---

### 2. DECLARATION BY THE SPECIALIST

I, Victor de Abreu declare that –

- I act as the independent specialist in this application;
- I am aware of the procedures and requirements for the assessment and minimum criteria for reporting on identified environmental themes in terms of sections 24(5)(a) and (h) and 44 of the National Environmental Management Act (NEMA), 1998, as amended, when applying for environmental authorisation which were promulgated in Government Notice No. 320 of 20 March 2020 (i.e. “the Protocols”) and in Government Notice No. 1150 of 30 October 2020.
- I will perform the work relating to the application in an objective manner, even if this results in views and findings that are not favourable to the applicant;
- I declare that there are no circumstances that may compromise my objectivity in performing such work;
- I have expertise in conducting the specialist report relevant to this application, including knowledge of the Act, Regulations and any guidelines that have relevance to the proposed activity;
- I will comply with the Act, Regulations and all other applicable legislation;
- I have no, and will not engage in, conflicting interests in the undertaking of the activity;
- I undertake to disclose to the applicant and the competent authority all material information in my possession that reasonably has or may have the potential of influencing –
  - any decision to be taken with respect to the application by the competent authority; and;
  - the objectivity of any report, plan or document to be prepared by myself for submission to the competent authority;
- All the particulars furnished by me in this form are true and correct; and
- I realise that a false declaration is an offence in terms of Regulation 48 and is punishable in terms of section 24F of the NEMA Act.



---

Signature of the Specialist

SMEC South Africa (Pty) Ltd

---

Name of Company:

05 Aug 2024

---

Date

**SPECIALIST DECLARATION FORM – AUGUST 2023**

---

**3. UNDERTAKING UNDER OATH/ AFFIRMATION**

I, Victor de Abreu, swear under oath / affirm that all the information submitted or to be submitted for the purposes of this application is true and correct.

---

Signature of the Specialist

---

SMEC South Africa (Pty) Ltd

---

Name of Company

---

5 Aug 2024

---

Date

---

*DAVIDENE AMERICA*

---

Signature of the Commissioner of Oaths

---

*05 | 08 | 2024*

---

Date

**DAVIDENE AMERICA**  
Senior Proposal Administrator  
Commissioner of Oaths  
Area: Johannesburg North  
Date: 31 January 2022  
Reference: RO-05/01/2022  
267 Kent Avenue, Ferndale, Randburg, 2194

## Appendix M – Specialist Detailed CV





### Personal Information

- ID no.: 631029
- Nationality: South African

### Years of Industry Experience

- 34+ years

### Qualifications and Memberships

- Master of Science in Engineering, University of Witwatersrand, 11/12/1990
- Bachelor of Science in Civil Engineering, University of Witwatersrand, 10/12/1985
- Graduate Diploma in Engineering, University of Witwatersrand, 13/12/1988
- Professional Engineer (ECSA) – Membership No. 950108, 16/03/1995
- Fellow (SAICE) - Membership No. 038948

### Key Skills and Competencies

- Transport Planning
- Traffic Engineering
- Highway Design
- Highway Management
- Sustainable Transport
- Business Development
- Strategic Management
- Project Management
- Skills Development & Mentoring

### Professional Overview

Victor de Abreu is a registered Professional Civil Engineer with over 33 years' experience in the Traffic and Transport planning field. He holds a BSc, MSc and GDE from WITS University.

Victor has worked in both the private and public sectors (municipal and provincial level) in South Africa and in the United Kingdom as a consultant.

Although his main field of expertise is Transport Planning and Traffic Engineering, he has operated in environments with an infrastructure focus particularly related to Roads and Stormwater management and design.

Rail, event planning and the effect of the 4th industrial revolution on transport are other speciality areas that Victor has a particular interest in.

Victor has held senior management positions in medium and large consultancy environments and serves in a voluntary capacity in SAICE as well as at board level in the education sector. Victor currently sits on the Board of SMEC South Africa

### Relevant Project Experience

#### JU0116: New City (Project name under NDA), Western Region, Saudi Arabia

**Client:** (undisclosed under NDA) | **Date:** Jan 2022 – Ongoing

**Client Contact Details:** (undisclosed under NDA).

**Consultant details:** Sybille Tildsley, Consultant Representative, Surbana Jurong, Email: [sybille.tildsley@smec.com](mailto:sybille.tildsley@smec.com)

**Description:** Mega project located in the middle east

**Role and Responsibilities:** Technical Transportation Lead responsible for delivery of the mobility planning aspects

#### C1965: Lake Volta Masterplan, Ghana | R 1 700 000

**Client:** Volta River Authority (VRA) | **Date:** 2022 – Jan 2024

**Client Contact Details:** SMEC Ghana, Paulo Trindade, [paulo.trindade@smec.com](mailto:paulo.trindade@smec.com)  
Ph: +212 537 650 575

**Description:** Masterplanning around the Lake Volta Transport Regional and selected Urban Areas and Infrastructure planning only selected urban areas of Phase 1 and Phase 2

**Role and Responsibilities:** Technical Lead Transportation Engineer responsible for the technical team lead, supervision and reviewing of all reports, tasks and submissions

#### J0063 Greater Diepsloot Transport Master Plan for the City of Johannesburg | R 2.1 million

**Client:** City of Johannesburg | **Date:** 2021 – June 2023

**Client Contact Details:** Esther Letlhaka, Ph: 011 688 7851

**Description:** Development of a Transport Masterplan for the Greater Diepsloot Area

**Role and Responsibilities:** Technical Lead Transportation Engineer responsible for the technical team lead, supervision and reviewing of all reports, tasks and submissions

#### JT0060 Feasibility Study the Introduction of an Integrated Corridor Management Approach for the Orange Farm-Johannesburg Inner City Corridor in the City of Johannesburg | R 3.9 Million

**Client:** Johannesburg Development Agency | **Date:** 09/06/2021 – 09/10/2022

**Client Contact Details:** Nobuntu Duze Ph: 011 688 7851

**Description:** Feasibility study into the introduction of an Integrated Corridor Management ICM which is the management of a Transport Corridor including Public Transport Traffic Management Infrastructure and other elements as a system rather than with individual Transport Modes and elements acting independently.

**Role and Responsibilities:** Project Director responsible for overall project management, oversight, review and client liaison

**XL0048: Mega-Project in Kingdom of Saudi Arabia (Feasibility and Concept Design) – under NDA | Fee Value: SMEC Africa: USD 212 486; SMEC South Africa: R 14 179 869, 35**

**Client:** Bureau Proberts | Date: Oct 2020 – Ongoing

Client Contact Details:

**Description:** Mega project located in the Middle East. SMEC International signed a Contract with an international architect, Bureau Proberts, who won a design competition for the design of a Lake and Lake Village.

SMEC South Africa is required to provide input to the Feasibility and Concept Design for various Infrastructure components; Dam, Geology, Hydrology, Power, Mobility Planning & Urban Infrastructure of the Lake and Village.

**Role and Responsibilities:** Lead Transportation Engineer responsible for mobility planning input

**DD0098: Public Transport Plan for Durban Inner City and Outer Ring (Planning), KZN South Africa | R 10 million**

**Client:** eThekweni Transport Authority (ETA) | Date: Nov 2017 – Current

**Client Contact Details:** Robin Chetty; Head PT Planning Ph +27 83 329 2029.

**Description:** Develop and assess plans, using EMME, Transcad and Aimsun, to improve PT within the Durban Inner City and Outer Ring area, to accommodate future densification within the Inner City of Durban with a 2040 horizon including conceptual design of identified infrastructure interventions as well as Public Transport operational plans for the short, medium and long term.

**Role and Responsibilities:** Project Director responsible for overall project oversight, Transport engineering, and Technical Reviewer

**DD0100: Detailed Public Transport Study for Hill Street Public Transport Precinct, KZN South Africa | R 4 million**

**Client:** eThekweni Transport Authority (ETA) | Date: Jan 2018 – Current

**Client Contact Details:** Robin Chetty; Head PT Planning Ph +27 83 329 2029.

**Description:** The Hill Street PT node within Pinetown is congested and needs to integrate well with the new C3 Corridor BRT route. The project was aimed at investigating the situation and recommending and detailing a concept that would result in short and long term improvements to transport in the Pinetown central area.

**Role and Responsibilities:** Project Director responsible for overall project oversight, Transport engineering, and Technical Reviewer

**JT0041 Scenario Fare Testing for Gautrain Phase 2 (Modelling), GP South Africa | R 2.1 million**

**Client:** Gautrain Management Agency (GMA) | Date: 2017, 2018, 2019

**Client Contact Details:** Victor Shange; Senior Manager: Civil, Perway and Structures; Ph +27 60 995 3059

**Description:** Assessing the operational and financial impact of fare variability in the Gauteng Rapid Rail Integrated Network (Gautrain Phase 2) with a view to advising provincial treasury of the impact of increasing accessibility through reducing fares on the system.

**Role and Responsibilities:** Project Director. Overall Project Management and input

**JT0042 The Collection, Compilation and Analysis of Private and Public Transport Data in the North-East Quadrant Area of Johannesburg, South Africa | R10m**

**Client:** City of Johannesburg (CoJ) | Date: 16/05/2018 – 16/10/2019

**Client Contact Details:** Lisa Seftel, Executive Director - Transportation, Ph +27 82 301 6826.

**Description:** Collection of relevant demand, supply and utilization information on the current public and private transport services and utilisation information within the North East Quadrant (NEQ) area of Johannesburg. The information was used to determine compensation for paratransit services replaced by the CoJ Rea Vaya Phase 1C BRT system.

**Role and Responsibilities:** Project Director responsible for oversight, Transportation Engineering, Technical Advisor and Reviewer.

**Kigali Transport Master Plan Implementation Report Update & GIS Database | R3m**

**Client:** City of Kigali (CoK) | Date: 2018 – 2019

**Client Contact Details:** Mr Mugabo Vianney; Ph: +250 788 355 357

**Description:** A transport masterplan was developed for the City of Kigali in Rwanda. The masterplan addressed significant expected

economic growth in the city. The plan was supported by a Macro Demand Model. The road network demand model was used to assess the re-routing of traffic as a result of the socio-economic development plan, planned road network improvements and other demand management interventions. The model is based in the PTV Visum software.

**Role and Responsibilities:** Project Director

## **M1, M2, M70 Road Masterplan and Simulation Model, Johannesburg, | ± R 3 700 000**

**Client:** Johannesburg Roads Agency | **Date:** 2017

**Client Contact Details:** Alan Robinson; Project Manager, Ph +27 62 519 0397

**Description:** The development of a SATURN simulation model to test various proposed road infrastructure improvements and to determine the demand that has to be accommodated on the network. The process involved interaction with the City of Johannesburg's multi-modal demand model. The forecast demand flows were extracted from the SATURN model and used to develop the road master plan and provided to the design teams to inform the detailed geometric designs and micro-simulation where relevant.

**Role and Responsibilities:** Project Director

## **OR Tambo SATURN TIA | R700k**

**Client:** AMCE on behalf of Mangaung Department of Settlements | **Date:** 2018

**Client Contact Details:** Givon Van Eyck; Business Development Manager, Ph +27 11 312 1569

**Description:** Development of a SATURN Model to test the impact of a mixed use development in Mangaung, Bloemfontein. The development is made up of Vista Park 2, 3 and Hillside View with approximately 18 282 residential units to be built within a space of 10 years. The SATURN model took into consideration all latent right demand in the Mangaung area and made appropriate recommendations in terms of upgrade apportionment.

**Role and Responsibilities:** Project Director

## **Tswaing Mega-City Development TIA | R568 168**

**Client:** Makole Property Developers | **Date:** 2017, 2018

**Description:** Development of a SATURN Model to test the impact of the proposed Tswaing Mega City Development on the surrounding road network in the immediate vicinity of the development site. The development will comprise of 510 hectares of mixed land use with approximately 50 000 residents. The development will consist of seven township extensions, namely Tswaing X8, X9, X10, X11A, X11B, X11C and X11D.

**Role and Responsibilities:** Project Director

## **JT0059 Traffic Impact Study of Line 2B City of Tshwane | R324 042**

**Client:** Koleko Solutions (Pty) Ltd on behalf of the City of Tshwane | **Date:** 2017

**Description:** SMEC South Africa was appointed to undertake AIMSUN Simulations Modelling and to revise the Traffic Impact Study of Line 2B BRT. The traffic impact study investigated the impact of introducing BRT on the road network currently utilised by normal traffic. Various scenarios were investigated including whether BRT should run on right of way lanes or whether it should operate on mixed traffic lanes.

**Role and Responsibilities:** Project Director responsible for Project Oversight, Transportation Engineer, Technical Advisor and Reviewer

## **ZL0035: Imbuga City Walk Project | R286 079.60**

**Client:** Kigali City | **Date:** 2017

**Description:** The City of Kigali appointed SMEC South to assist with traffic engineering solutions in the pedestrianisation of KN4 Avenue in Kigali. The task was to assess the impact of the closure of KN4 Avenue to normal traffic and recommend solutions to minimise impact and improve circulation within the city.

**Role and Responsibilities:** Project Director. The task was to assess the impact of the closure of KN4 Avenue to normal traffic and recommend solutions to minimise impact and improve circulation within the city.

## **COJ Eco Mobility Festival Transport Planning | R2 477 618**

**Client:** City of Johannesburg | **Date:** 2016

**Client Contact Details:** Lisa Seftel; Director Transportation, Ph +27 83 231 0380, E [lisas@joburg.org.za](mailto:lisas@joburg.org.za)

**Description:** Project management of planning and implementation of interventions for the Eco Mobility Festival held in Sandton in 2015. This festival focused on transforming the neighbourhood of Sandton for an entire month and demonstrated the possibilities

of enhancing travel through integrated, socially inclusive, and environmentally friendly options: namely walking, cycling, and public transport.

**Role and Responsibilities:** Project Director. Project Management; Planning; Design; Execution; Review.

## Traffic Impact Assessments | R239 724

**Client:** City of Johannesburg | **Date:** 2015 – 2016

**Client Contact Details:** Various

**Description:** Various TIA's including area wide studies such as Patterson Park to support concept of BRT in the city.

**Role and Responsibilities:** Project Director. Project Management; Planning; Design; Execution; Review.

## Rea Vaya Section 9 Transport Planning | R205 136

**Client:** City of Johannesburg | **Date:** 2014 – 2015

**Client Contact Details:** Adrian Brislin, Ph +27 82 600 6757

**Description:** Concept planning of Section 9 of the City's BRT network from Sandton to Randburg.

**Role and Responsibilities:** Project Director responsible for project Oversight, Transportation Engineer, Technical Advisor and Reviewer.

## COJ Guidelines for Transport Assessments | R973 747

**Client:** City of Johannesburg | **Date:** 2015

**Client Contact Details:** Nobuntu Ciko; Project Manager, Ph +27 11 870 4508

**Description:** Development of guidelines for transport assessments for the city with a focus on moving away from a private vehicle to a public transport and non-motorised transport (NMT) focused approach / environment.

**Role and Responsibilities:** Project Director. Overview, Design and Review.

## DOT National Transport Masterplan | R789 800

**Client:** National Department of Transport | **Date:** 2013 – 2015

**Description:** National Transport Masterplan. Involved with the modelling activities related to the inventory, analysis, forward planning and implementation phases of this project.

**Role and Responsibilities:** Project Director. Involved with the modelling activities related to the inventory, analysis, forward planning and implementation phases of this project.

## COT Feeder Network for Phase 1 and 2 of the TRT. | R817 500

**Client:** City of Tshwane | **Date:** 2013 – 2015

**Client Contact Details:** Givon Van Eyck, Ph +27 84 279 6759, E gvaneyck@amce.co.za

**Description:** Planning and Design for implementation of the TRT feeder network bus stop infrastructure and road network upgrades for Phase 1 and 2 of the City's TRT rollout plan.

**Role and Responsibilities:** Project Director. Project Management; Overview, Design and Review.

## COT TRT Feeder Bus Infrastructure Design | R817 500

**Client:** City of Tshwane | **Date:** 2013 – 2015

**Client Contact Details:** Givon Van Eyck, Ph +27 84 279 6759, E gvaneyck@amce.co.za

**Description:** Planning and Design for implementation of the TRT feeder network bus stop infrastructure.

**Role:** Project Director. Project Oversight, Transportation Engineer, Technical Advisor and Reviewer

## JRA Roads and Stormwater Standards | R968 303

**Client:** Johannesburg Roads Agency (JRA), | **Date:** 2014

**Client Contact Details:** Philiswe (Gugu) Mbambo, Deputy Direct: Transport Planning and Policy, Ph +27 82 301 6826, E PhilisweM@joburg.org.za

**Description:** Project lead for the development of Roads and Stormwater standards for the Johannesburg Roads Agency.

**Role and Responsibilities:** Project Director

## COT Development of an NMT Policy | R800k

**Client:** City of Tshwane | **Date:** 2013 – 2014

**Client Contact Details:** Bavusile Ramekane, Ph +27 12 358 7822, E bavusiler@tshwane.gov.za

**Description:** Project lead for City of Tshwane 3-year as and when Traffic Investigations project with projects including development of an NMT Policy for the City, safety assessments on identified high accident zone corridors, NMT and pedestrian assessments as well as review of various Traffic Impact Assessments on behalf of the City.

Role and Responsibilities: Project Director

### **COT Soshanguve to CBD BRT Planning | R3.5 million**

**Client:** City of Tshwane | **Date:** 2010 – 2014

**Client Contact Details:** Bavusile Ramekane, Ph +27 12 358 7822, E bavusiler@tshwane.gov.za

**Description** Concept planning of initial Tshwane Rapid Transit corridor from Soshanguve to CBD in the north of Tshwane.

**Role and Responsibilities:** Project Director. Project Oversight, Transportation Engineer, Technical Advisor and Reviewer

### **DPW Traffic Analysis of Operational Aspects | R800k**

**Client:** National Department of Public Works | **Date:** 2007 – 2014

**Description:** Traffic analysis of operational aspects related to Lebombo border post including assessment of freight, public transport and general traffic flow – the outcomes of this assessment will be utilized to appropriately design infrastructure for the reconstructed facility.

Role and Responsibilities: Project Director.

### **COT Design of Line 2C of the COT TRT | R3 781 701**

**Client:** City of Tshwane | **Date:** 2013

**Client Contact Details:** Lloyd Moti; Ph +27 84 422 3544, E lmoti@amce.co.za

**Description** Design of section of Line 2C of the COT TRT system from Menlyn to Mamelodi.

**Role and Responsibilities:** Project Director. Project Oversight, Transportation Engineer, Technical Advisor and Reviewer

### **Rea Vaya Phase 1C Traffic and NMT Assessments | R21 453 795**

**Client:** City of Johannesburg | **Date:** 2012

**Client Contact Details:** Siyabonga Genu, Ph +27 11 688 7823, E sgenu@jda.org.za

**Description:** The project entailed being the Traffic discipline lead for traffic assessment of Sections 8 and 15 of the City of Johannesburg Rea Vaya Phase 1C Bus Rapid Transit project including assessment of non-motorised transport requirements adjacent to stations.

**Role and Responsibilities:** Project Director. Overall project management

### **COJ Traffic Signal Phasing | R1 million**

**Client:** City of Johannesburg | **Date:** 2006 – 2011

**Description:** Involved with the collection of intersection configuration, road signs and marking and traffic signal inventory of identified intersections within the Greater Johannesburg area as well as undertaking the necessary traffic counts, traffic signal design and phasing.

Role and Responsibilities: Project Director

### **DPW Drafting of PDR | R2 307 602**

**Client:** National Department of Public Works | **Date:** 2005 – 2011

**Description:** Drafting of PDR for Maseru South African High Commission headquarters.

Role and Responsibilities: Project Director

### **2010 FIFA World Cup™ Transport Operations Plan (TOP) | R300k**

**Client:** City of Johannesburg | **Date:** 2009 – 2010

**Client Contact Details:** Philiswe (Gugu) Mbambo, Deputy Direct: Transport Planning and Policy, Ph +27 82 301 6826, E PhilisweM@joburg.org.za

**Description:** Member of team appointed to develop the 2010 FIFA World Cup™ Transport Operations Plan (TOP) for the City of Johannesburg.



**Role and Responsibilities:** Project Director

## **COJ Gauteng Freeway Improvement Scheme (GFIS) | R1 million**

**Client:** City of Johannesburg | **Date:** 2009-2010

**Description:** Assessment of the impact of the Gauteng Freeway Improvement Scheme (GFIS) on the road system in the city.

**Role and Responsibilities:** Project Director

## **DPW Drafting of Preliminary Design Report (PDR) for Carletonville Police Precinct | R1.1 million**

**Client:** National Department of Public Works | **Date:** 2005 – 2010

**Description:** Drafting of Preliminary Design Report (PDR) for Carletonville Police Station that had been decommissioned due to risks associated with sinkhole formation due to dolomites.

**Role and Responsibilities:** Project Director

## **ORTIA Assessment of Traffic Impacts | R1 720 853**

**Client:** OR Tambo International Airport | **Date:** 2008 – 2009

**Description:** Assessment of traffic impact landside as a result of predicted passenger growth airside.

**Role and Responsibilities:** Project Director

## **ORTIA Traffic Study | R450k**

**Client:** OR Tambo International Airport | **Date:** 2008 – 2009

**Description:** Traffic Study of entrance and exit to new Multi Storey Parkade 3 and capacity analysis of Spine Road at critical points at ORTIA.

**Role and Responsibilities:** Project Director

## **DOT Initial Transport Operations Plan (INTOP) | R250k**

**Client:** National Department of Transport | **Date:** 2007 – 2008

**Description:** Member of team responsible for drafting the Initial Transport Operations Plan (INTOP) for the NDoT for FIFA World Cup™.

**Role and Responsibilities:** Project Director.

## **COJ Randburg CBD Upgrade Planning | R400k**

**Client:** City of Johannesburg | **Date:** 2005 – 2007

**Description:** Recommendations of road network upgrades to support Randburg CBD revitalization initiative.

**Role and Responsibilities:** Project Director

## **ACSA Passenger Growth Study at Cape Town, George, BFN, and Kimberley Airports | R2 million**

**Client:** ACSA | **Date:** 2005 – 2006

**Description:** Cape Town, George, Bloemfontein and Kimberly Airports – Estimation of projected passenger growth at these airports, made recommendations on land-side response in term of infrastructure requirements such as capacity of access roadways as well as internal Parking requirements..

**Role and Responsibilities:** Project Director

## **ETA Assessment of Parking Requirements | R3.5m**

**Client:** Ethekwini

**Description:** Assessment of parking requirements and recommended upgrade of municipal precincts.

**Role and Responsibilities:** Project Director

## **ETA Undertaking of Public Transport Study in Welbedacht | R2 million**

**Client:** Ethekwini

**Description:** Undertaking of public transport study in Welbedacht area to identify requirements for wider community.

**Role and Responsibilities:** Project Director

## **ORTIA Traffic Operations | R900k**

**Client:** OR Tambo International Airport

**Description:** Project management of review of traffic operations and flow at freight cargo facility/terminal

**Role and Responsibilities:** Project Director

## **GPG Building Capacity within the Planning Directorate**

**Client:** Gauteng Provincial Government

**Description:** Building capacity within the planning directorate and assuming mentorship role for internal staff.

**Role:** Project Director

## **GPG Audits**

**Client:** Gauteng Provincial Government

**Description:** Audit and make recommendations on the restructuring of the Planning Directorate in the Department.

**Role:** Project Director

## **GPG Project Management**

**Client:** Gauteng Provincial Government

**Description:** Project management of the transportation requirements for the 2010 World Cup™ at a provincial level.

**Role:** Project Director

## **GPG Review of Gauteng Strategic Road Network**

**Client:** Gauteng Provincial Government

**Description:** Project management and review of the Gauteng Strategic Road Network.

**Role:** Project Director

## **GPG Freight Implementation Strategy for Gauteng**

**Client:** Gauteng Provincial Government

**Description:** Project management and the development of a Freight Implementation Strategy for Gauteng.

**Role:** Project Director

## **Regional Call Centre for the 2010 FIFA World Cup™**

**Client:** Gauteng Provincial Government

**Description:** Initiate project to develop a regional Call Centre for the 2010 FIFA World Cup™.

**Role:** Project Director

## **GPG Integrated Ticketing Strategy for Gauteng**

**Client:** Gauteng Provincial Government

**Description:** Advisory on project initiated to assess an Integrated Ticketing Strategy for Gauteng.

**Role:** Project Director

## **GPG Advisory on Traffic Impact Studies for Various Regional Developments in Gauteng**

**Client:** Gauteng Provincial Government

**Description:** Advisory on traffic impact studies for various regional developments in Gauteng.

**Role:** Project Director

## **GPG Public Transport Integration within the Province | R80k**

**Client:** Gauteng Provincial Government

**Description:** A Represent the department in discussion with Gautrain regarding public transport integration within the province.

**Role:** Project Director

## GPG Development of Concept for Gauride System | R800k

**Client:** Gauteng Provincial Government

**Description:** Development of concept for Gauride system for the 2009 FIFA Confederations Cup™.

**Role:** Project Director

## DPW Assessment of Options to Improve Traffic Operations at Maseru Border Post. | R1 million

**Client:** National Department of Public Works

**Description:** Assessment of options to improve traffic operations at the South Africa-Lesotho Maseru border post.

**Role:** Project Director

## Professional History

- 2017 – Date | Function General Manager  
| SMEC South Africa (Pty) Ltd
- 2005 – 2017 | Director  
| MPA Consulting Engineers
- 2003 – 2005 | Member  
| VSM Projects
- 2001 – 2003 | Principal Engineer  
| Mouchel Consulting Engineers, United Kingdom
- 1995 – 2001 | Head of Public Transport Planning  
| Greater Johannesburg Metropolitan Council
- 1990 – 1995 | Assistant Town Engineer  
| Sandton Town Council
- 1988 – 1990 | Graduate Engineer  
| De Leuw Cather Consulting Engineers

## Courses & Conferences attended

N/A

## Publications & Papers Presented

2015: Feasibility study on traffic decongestion strategies at Maseru bridge border post South African Transport Conference (2015).

2017: Post Eco-Mobility experiences and lessons learnt (under development) South African Transport Conference (2017).

On-going: External examiner for various MSc dissertations at the University of Pretoria.

On-going: Peer Review papers on NMT and Public Transport Operations for South African Transport Conference (SATC).

## Language Skills

Mother Tongue:	English		
Languages	Speak	Read	Write
English	Excellent	Excellent	Excellent
Afrikaans	Good	Good	Good
French	Basic	Basic	Basic
Portuguese	Good	Basic	Basic



## SMEC Johannesburg

267 Kent Avenue  
Ferndale, Johannesburg , South Africa 2194

**Phone:** +27 11 369 0600

**Email:** [victor.deabreu@smec.com](mailto:victor.deabreu@smec.com)

## engineering positive change

SMEC simplifies the complex. We unlock the potential of our people to look at infrastructure differently, creating better outcomes for the future.

[www.smec.com](http://www.smec.com)